



SIKA
MARINE



THE
PROFESSIONAL'S
CHOICE

SIKA MARINE SYSTEMS PROVEN SOLUTIONS FOR COMFORT AND SAFETY

BUILDING TRUST



THE FASTEST, STRONGEST AND MOST FLEXIBLE MORTARS

Sika provides direct glazing, teak decking, exterior and interior sealing and bonding, as well as acoustic flooring systems in the manufacturing and repairing of leisure boats, commercial vessels and offshore platforms. Our elastic bonding and sealing solutions are designed with the harsh marine environment in mind: resistance to water, sun, cleaning chemicals and fatigue.

Sika offers a range of flooring products, each of which have a leveling and smoothing aspect, as well as varying degrees of noise and vibration reduction properties. All this, coupled with fire performance, assures that the requirements of both ship owners and regulatory bodies are met.



CONTENT

Sikafloor® Marine Systems - Product and system selection guide	5
Sikafloor® Marine Systems - Deck covering	6 - 9
Sikafloor® Marine Systems - Floating floors	10 - 13
Sikafloor® Marine Systems - Vibration/Visco-elastic/Green technology	14 - 21
Sikafloor® Marine Primer	22 - 23
Sikafloor® Marine Systems - Decorative floors	24 - 31
Sika Marine - Sealing and bonding technology/Products	32 - 43
Sika Marine - Application guide	44 - 71
Recommendations for Sika Marine range	72
Product data and abbreviations	73
Glossary of terms	74 - 75

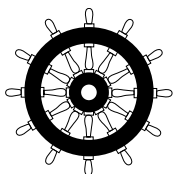

All Products and Systems
are Wheelmarked.
DNV Certified.

PROVEN SOLUTIONS FOR COMFORT AND SAFETY

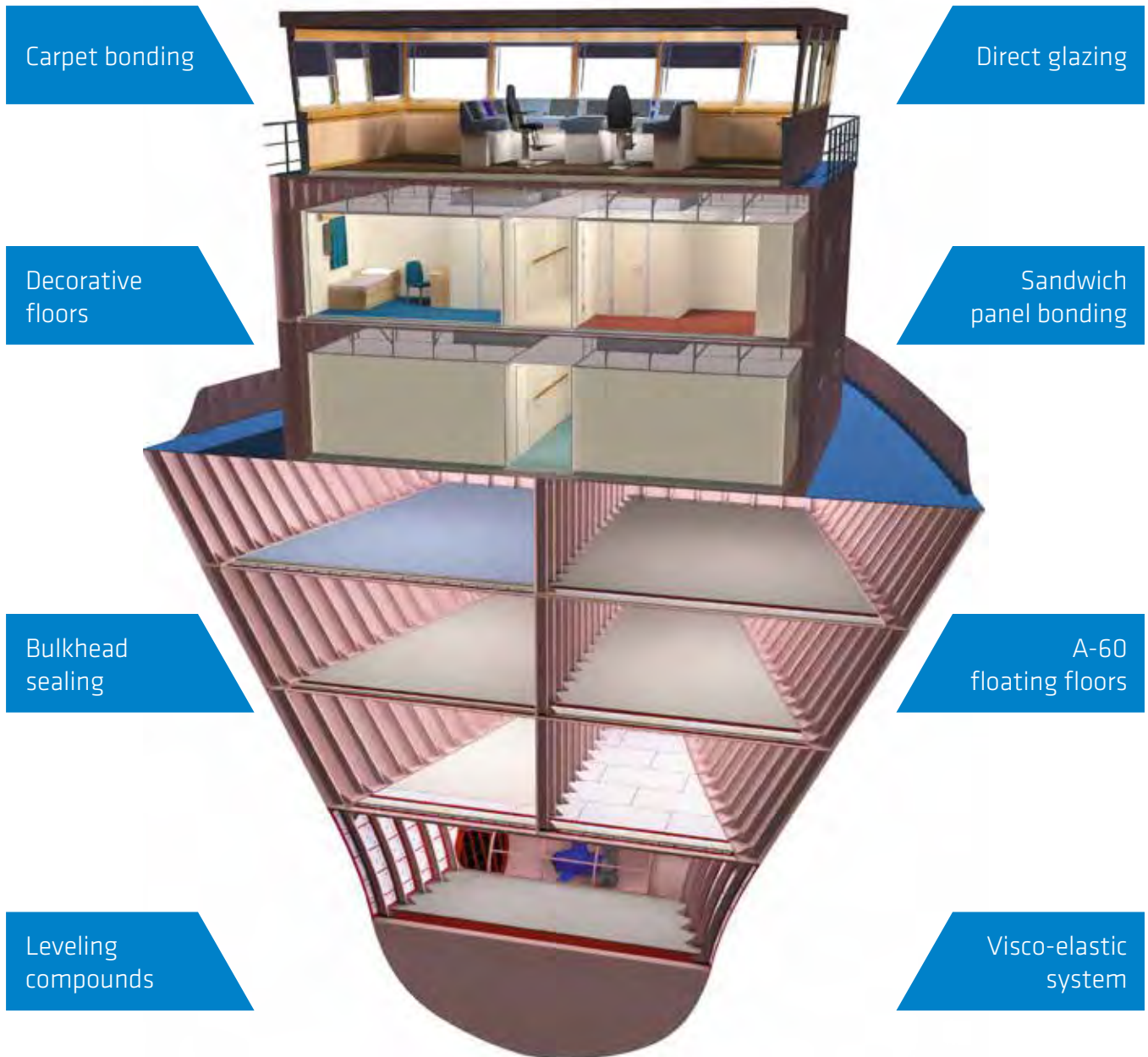

MARINE ABC

- IMO - International Maritime Organisation
- SOLAS - Safety and life at sea
- Sound Regulation MSC 337 (91) - code of noise levels on board ships
- Fire test procedure code (FTP Code 2010)
- Classification Societies rules

Sikafloor® Marine SYSTEMS PRODUCT AND SYSTEM SELECTION GUIDE

Sikafloor® Marine SELF LEVELING COMPOUNDS

To be able to give the applied carpets, vinyl, tiles etc. a perfect smooth look it is important that the underlayment has a smooth surface. This can be ensured by using the 1-component, pumpable technology of self leveling mortars from Sika. In addition to build other Sikafloor® systems, the Sikafloor® Marine self leveling products can be applied on top of existing hard foundations such as concretes and steel.

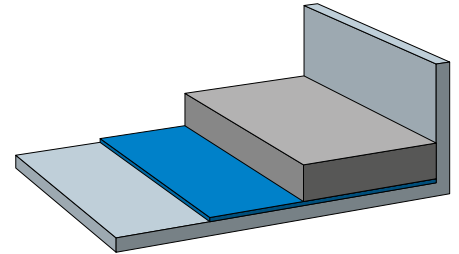

Sikafloor® Marine LEVELING AND FAST CURING COMPOUNDS

Sikafloor® Marine leveling compounds are based on a 1-component pumpable technology from Sika. The solutions provide cost effective benefits for the shipyard and installation team in logistics, handling and time of installation. Sikafloor® Marine self leveling and fast curing compounds can easily be mixed using only a handheld mixer or a pump. The leveling compounds can be trowelled and are as well suitable for slopes.

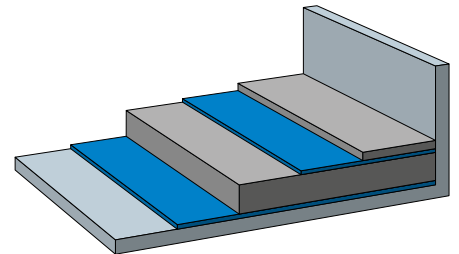

Sikafloor® Marine FLOATING FLOORS

Sikafloor® Marine floating floor systems consist of a mineral wool layer on which either a non-combustible 1-component fast curing compound or steel or alu plates are applied. These build-ups give maximum sound reduction and provide a high degree of comfort for the crew onboard the vessel. The Sikafloor® Marine floating floors are all a part of an A-60 fire rated solution with building height of only 45 mm.

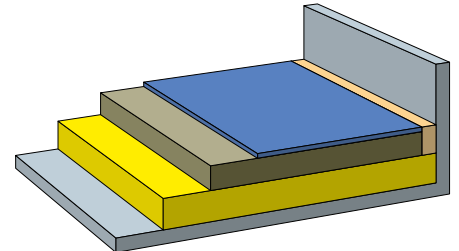

Sikafloor® Marine VISCO-ELASTIC FLOORS

Sikafloor® Marine visco-elastic floors are a build-up with a visco-elastic layer and a constrained layer applied on top. The constrained layer consists of a non-combustible 1-component compound of Sikafloor® Marine or it can be steel or alu tiles. The Sikafloor® Marine visco-elastic product is a special two-component polyurethane or mortar, with only one purpose - to dampen the vibrations in the structure.

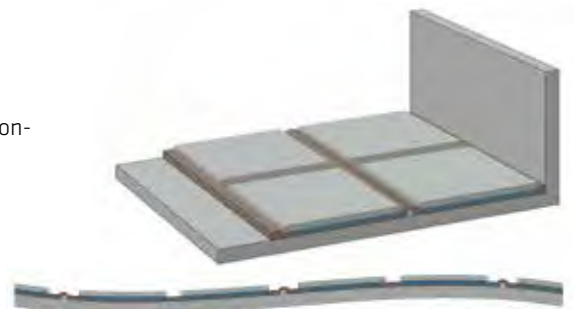

MARINE Sikafloor® Marine Primary Deck Covering

- 1-component
- Non-combustible
- Pumpable
- Leveling compound



DURABLE, RELIABLE AND APPROVED SYSTEMS

Our Sikafloor® Marine range offers ship refurbishment solutions for leveling, acoustic noise reduction and damping which allows new installations to be walked on in as little as 2 hours. Durable, lightweight and fire-rated, our systems fulfill IMO regulations as well as those of other major authorities and classification societies.

Ship builders are looking for quicker and more consistent building techniques and reduced costs, while designers want improved and innovative appearance, lower weight and better performance.

As a supplier and partner to the marine industry, Sika provides a range of state-of-the-art technology solutions to assist ship builders in meeting these challenges. Typically decks must be leveled to take out the unevenness of the ship's structure

and prepare it for the finished floor. Sikafloor® Marine self leveling primary deck coverings will level a ship deck to prepare it for the final floor surface. To be able to give the applied carpets, vinyl, tiles, etc. a perfect smooth look, it is important that the underlayment has a smooth surface.

Use Sikafloor® Marine self leveling primary deck coverings where the building height as well as the weight of the total underlayment can be limited.

Sikafloor® Marine leveling compounds are based on 1-component

pumpable technology from Sika. The pumpable solution provides cost effective benefits for the shipyard and installation team in logistics, handling and installation time.

The 1-component leveling solution for the steel or aluminium decks give the applicator a timesaving way to level the decks without sacrificing quality. Sikafloor® Marine products have IMO & US Coastguard certification.

>60 %

application time savings with Sikafloor® Marine visco systems

Up to 60 dB

airborne noise reduction with Sikafloor® Marine floating floors

>15,000

boats per year bonded with Sika

Sikafloor® Marine Systems

1-component, self leveling primary deck covering



Sikafloor® Marine-100

Self leveling mortar



- Light weight 1-component self leveling mortar
- Density app. 0.9 kg/L
- Applicable up to 10 mm
- Walkable after 12 hours
- Water for mixing 5,9 to 6,4L pr. 14 kg bag
- Application area: All dry, internal areas
- Material consumption 0,9 kg/mm/m²
- 3 mm layer as underlay for carpet
- 6 mm layer as underlay for vinyl

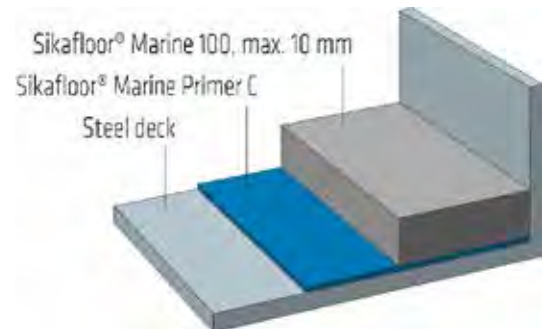

Sikafloor® Marine-107

Self leveling mortar



- Ultra light weight 1-component self leveling mortar
- Density app. 0.7 kg/L
- Applicable up to 10 mm
- Walkable after 12 hours
- Water for mixing 6,5 to 6,8L pr. 12 kg bag
- Application area: Inside cabins, light traffic, internal areas
- Material consumption 0,7 kg/mm/m²

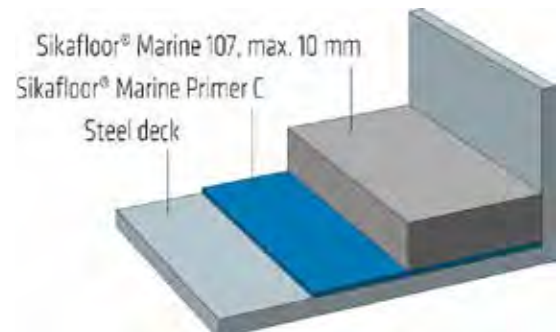

Sikafloor® Marine-120

Self leveling mortar



- Light weight 1-component self leveling mortar
- Density app. 0.9 Kg/L
- Applicable up to 30 mm
- Walkable after 12 hours
- Water for mixing 5,9 to 6,5L pr. 16 kg bag
- Application area: All dry and wet, internal areas, except for galley
- Material consumption 0,9 kg/mm/m²
- 3 mm layer as underlay for carpet
- 6 mm layer as underlay for vinyl
- SFM 530 possible as top layer

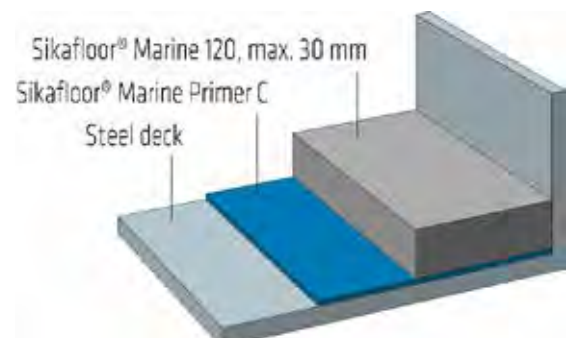

Sikafloor® Marine Systems

1-component, self leveling primary deck covering



Sikafloor® Marine-118 FC Fast curing self leveling mortar



- High weight 1-component fast curing self leveling mortar
- Density app. 1.8 kg/L
- Applicable up to 25 mm
- Walkable after app 2 hours
- Water for mixing 5,3 to 6,0L pr. 25 kg bag
- Application area: All dry and wet, heavy traffic, internal areas
- This product can be spike rolled
- For all top layers
- Material consumption 1,8 kg/mm/m²

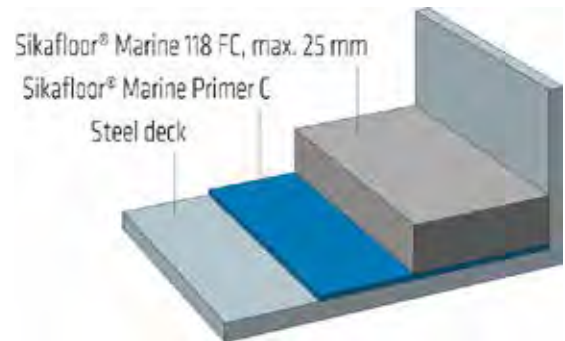

Sikafloor® Marine-190 Self leveling mortar



- Heavy duty 1-component self leveling mortar
- Density app. 1,8 g/cm³
- Applicable up to 10 mm (scratch coat from 0 mm)
- Walkable after 3 hours, depending on temp and ventilation
- Application area: All wet and dry internal areas, heavy duty areas
- Respect the mixing time
- Can be spike rolled

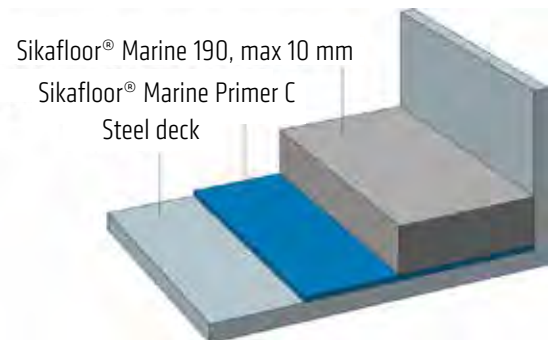

Self leveling mortars mechanical properties:

	Comp strenghts	Flexural strenghts	Modulus of elasticity
SFM 107	7 MPa	2,8 MPa	1,88 GPa
SFM 100	7 MPa	4,2 MPa	2 GPa
SFM 120	9 MPa	3,4 MPa	2,5 GPa
SFM 190	33 MPa	5 MPa	17 GPa
SFM 118 FC	35 MPa	7,7 Mpa	12,3 GPa

Sikafloor® Marine Systems

1-component, trowelable primary deck covering



Sikafloor® Marine-18

Trowel out mortar



- Heavy weight 1-component trowel out mortar
- Used as constrained layer
- Non combustible
- Density app. 1.8 kg/L
- Applicable up to 25 mm
- Walkable after 24 hours
- Water for mixing 2,7 to 3,3L pr. 25 kg bag
- Application area: All wet and dry internal areas
- Material consumption 1,8 kg/mm/m²

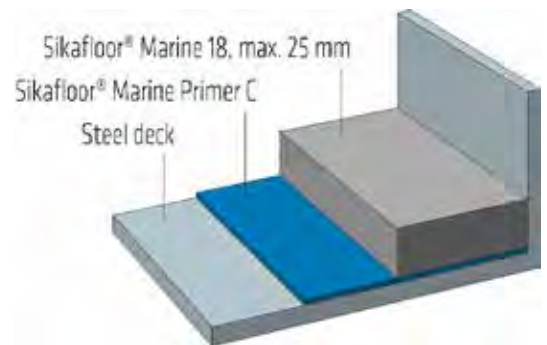

Sikafloor® Marine KG-202N

Trowel out mortar



- Medium weight 1-component trowel out mortar
- Non combustible
- Density app. 0.9 kg/L
- Applicable up to 100 mm
- Walkable after 10 hours
- Water for mixing 4,2 to 5,1L pr. 17 kg bag
- Application area: All dry and wet internal areas
- Can be used for ramps
- Material consumption 1,3 kg/mm/m²

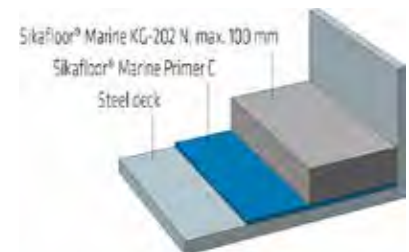
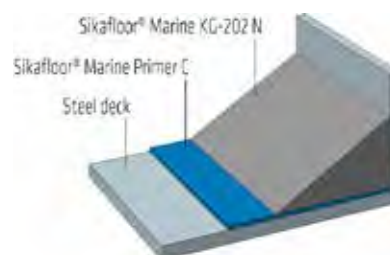

Sikafloor® Marine KG-404N

Trowel out mortar



- Medium weight 1-component trowel out mortar
- Non combustible
- Density app. 1.3 kg/L
- Applicable up to 100 mm
- Walkable after 10 hours
- Water for mixing 4,6 to 5,4L pr. 20 kg bag
- Application area: All dry and wet internal areas
- Can be used for ramps
- Material consumption 1,3 kg/mm/m²

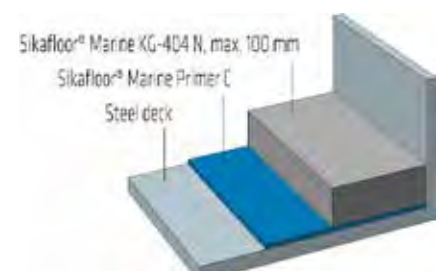
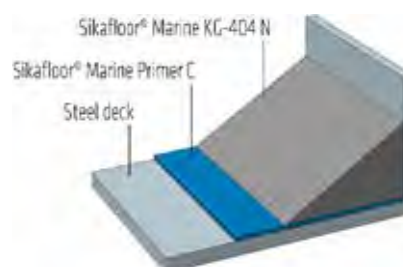

MARINE Sikafloor® Marine Litosilo Systems

A-60 Airborne and impact
noise reduction/Floating systems

Being onboard a commercial vessel or cruise ship means being exposed to noise 24 hours a day. Loud noise is coming from sources such as main engine, bow thrusters, HVAC-system and other electrical installations. If nothing is being done to reduce the problem, crew members can quickly start to get sick and feel dizzy and they will soon be a danger to themselves, the rest of the crew as well as the vessel.

Therefore, international authorities throughout the years have set the

standards very high when it comes to comfort onboard all commercial and passenger vessels. It is crucial for the crew to have an environment where they can work and, more importantly, where they can rest without being exposed to dangerous noise and vibrations.

Product Description

Sikafloor® Marine Litosilo systems are floating floor systems. The systems consist of mineral wool fireproof insulation and Sikafloor® Marine Litosilo mortar to reduce airborne and impact

noise. The systems also provide an A-60 solution with a building height as low as 45 mm. Sikafloor® Marine Litosilo systems can be combined with Sika Visco-Elastic systems to reduce both low frequency structure borne noise and higher frequency airborne noise for comfort class accommodation noise levels and A-60 fire protection.



Sikafloor® Marine Systems

Floating floors/Airborne and impact sound reduction solutions

Floating floor types

- 2 layers of steel with adhesive between applied on insulation
- Floors with polymer modified cementitious mortar (1-component)

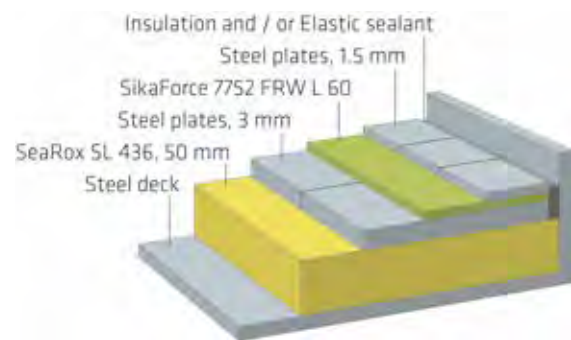
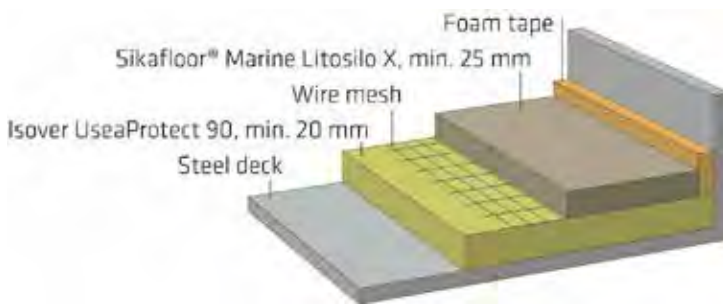

A-60 Floating floor

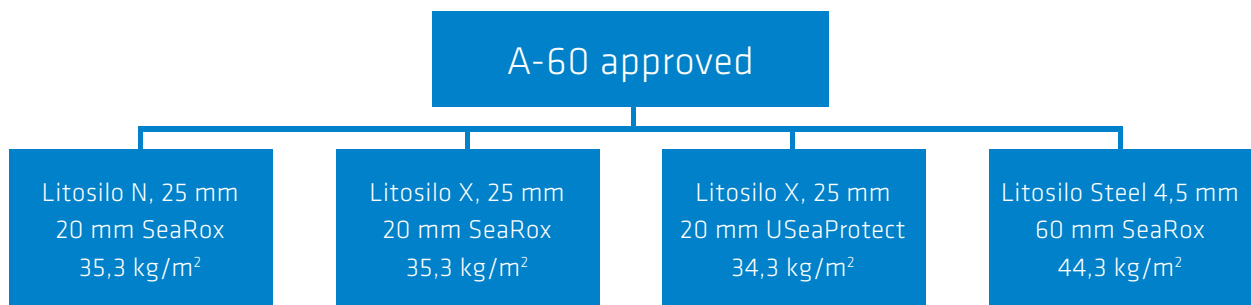

Sikafloor® Marine Systems

Floating floors/Airborne and impact sound reduction solutions



Sikafloor® Marine Litosilo N

Trowel out floating floor



- Medium weight 1-component trowel out mortar
- Non combustible
- A-60 approved from 45 mm
- Density app. 1.3 kg/L
- Applicable up to 100 mm
- Walkable after 10 hours
- Water for mixing 4,6 to 5,4L pr. 20 kg bag
- Application area: All dry and wet internal areas
- Can be used for ramps
- Material consumption 1,3 kg/mm/m²

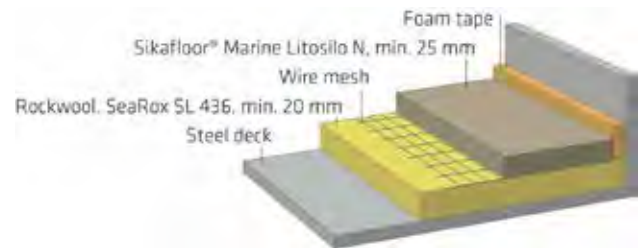

Sikafloor® Marine Litosilo X

Trowel out floating floor



- Medium weight 1-component trowel out mortar
- Non combustible
- Density app. 1.3 kg/L
- Applicable up to 100 mm
- A-60 approved from 45 mm
- Walkable after 3 hours
- Water for mixing 4,0 to 4,6L pr. 20 kg bag
- Application area: All dry and wet internal areas
- Can be used for ramps
- Material consumption 1,3 kg/mm/m²

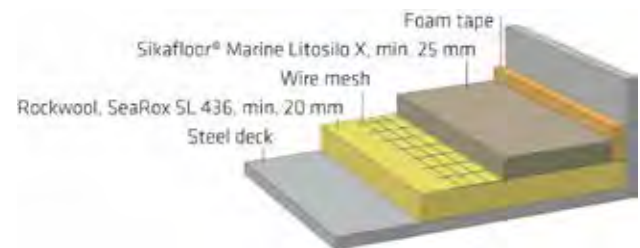
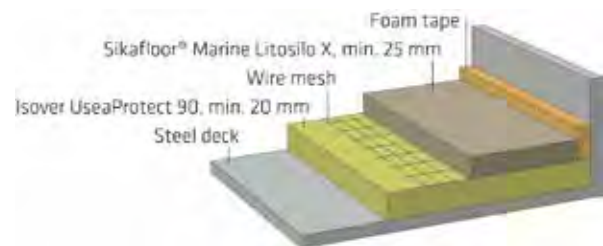

Sikafloor® Marine Litosilo Steel

Steel floating floor



- A-60 approved from 65 mm
- Levels out the deck
- High noise reduction performance
- Can be applied in one day

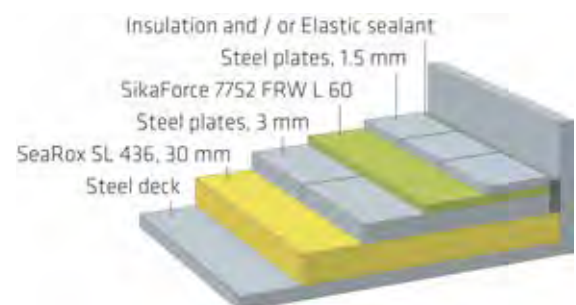

Sikafloor® Marine Systems

Floating floors/Airborne and impact sound reduction solutions

Sika system comparison

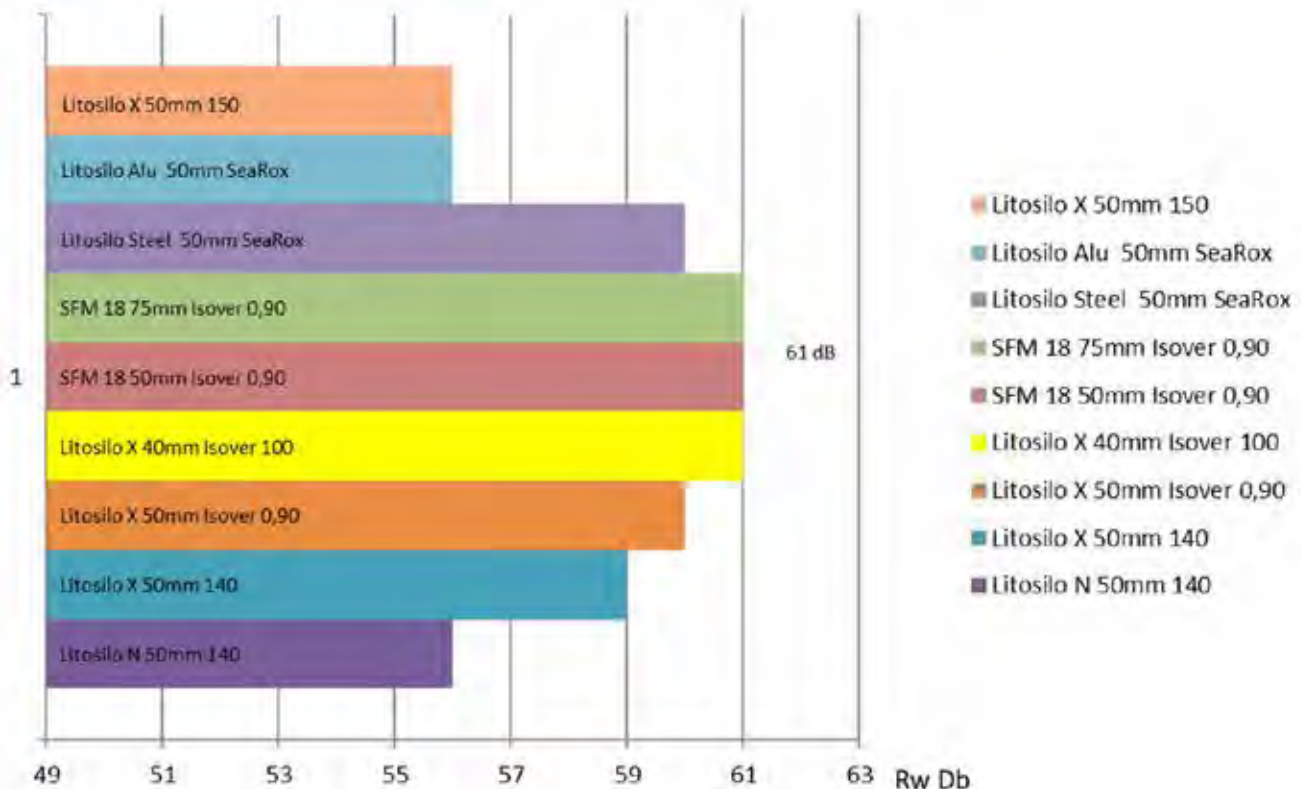

Acoustic values

System	Weight	Insulation		R _w	L _{nw}	STC	IIC
Litosilo N	39,5 kg/m ²	SeaRox 436	50mm	56 Db	61 Db	N/A	N/A
Litosilo X	36,5 kg/m ²	USeaProtect 90	50mm	60 Db	61 Db	60 dB	49 dB
Litosilo X	36,5 kg/m ²	USeaProtect 100	40mm	61 Db	59 Db	61 Db	51 dB
Litosilo X	39,5 kg/m ²	SeaRox 436	50mm	59 Db	60 Db	60 dB	51 dB
Litosilo X	40,0 kg/m ²	SeaRox 440	50mm	56 Db	65 Db	57 dB	45 dB
Litosilo Steel	46,3 kg/m ²	SeaRox 436	50mm	60 Db	53 Db	61 dB	56 dB
Litosilo Steel	46,3 kg/m ²	SeaRox 436	50mm	60 Db	53 Db	61 dB	56 dB

Values are taken from official test reports.

MARINE

Sikafloor® Marine

Visco-elastic systems

Noise sources like main engines, thrusters, pumps, generators, HVAC, loud music and foot traffic create not only airborne noise, but also a lot of vibrations in the whole structure.

Without treatment, vibration causes structure bone noise in the form of rattling and humming. This type of noise makes it difficult for communication and proper rest while on board the ship.

It is crucial for the crew to have an environment where they can work and,

more importantly, where they can rest without being exposed to dangerous noise and vibrations.

Sikafloor® Marine visco-elastic systems are built up with a flexible layer applied to the deck with a constrained layer installed on top.

The flexible visco-elastic layer is the Sikafloor® Marine VEM technology, a visco-elastic polymer modified mortar. The constrained layer is either a water-based cement mortar compound of

Sikafloor® Marine 18, Sikafloor® Marine 118 Fast Cure (FC), Sikafloor® Marine 190, or steel tiles. Sikafloor® Marine visco-elastic have the flexibility and the mass needed to dampen the vibrations of vessels, especially in the lower frequency range produced by engines, thrusters and other noise sources.

Sikafloor® Marine products have IMO & US Coastguard certification.

Sikafloor® Marine Systems

Vibration damping/Visco-elastic systems

Sikafloor® Marine VEM Alu Visco-elastic



- VEM X + Alu plates
- Tie coat on deck is a must to be rolled on
- Tie coat on back side of small Alu plates is a must, pre-applied
- Low building height solution
- Sensitive to deck straightness
- Weight from 6 to 10 kg/m²
- Consumption VEM Z: 1,3 kg/mm/m²
- Material consumption Alu plates 19 pcs/m²

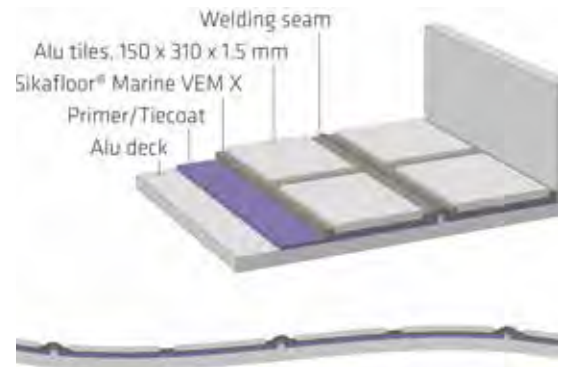

Sikafloor® Marine VEM 18/VEM 118 FC Visco-elastic



- VEM + SFM 18/SFM 118 FC
- Primer less application
- Trowel out solution
- Can be used in A-60 combinations
- Leveling and visco in one go
- Not sensitive to deck straightness
- Weight from 20 to 47 kg/m²
- Consumption VEM: 1,3 kg/mm/m²
- Consumption SFM 18/SFM 118 FC: 1,8 kg/mm/m²

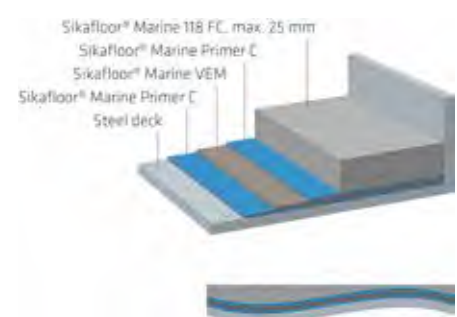
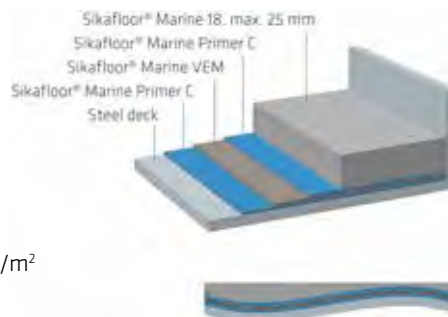

Sikafloor® Marine VEM Steel Visco-elastic



- VEM X + Steel plates
- Primer less application
- Low building height solution
- Sensitive to deck straightness
- Weight from 12 to 23 kg/m²
- Consumption VEM X: 1,3 kg/mm/m²
- Material consumption steel plates 19 pcs/m²

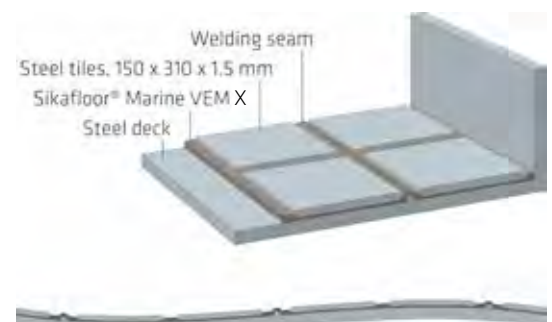

Sikafloor® Marine Systems

Combination floors

Combination of visco-elastic system + floating floor

- We get structure borne noise reduction from the visco
- We get airborne and impact noise reduction from the floating floor
- We have both with A-60 and not A-60
- How does it look?

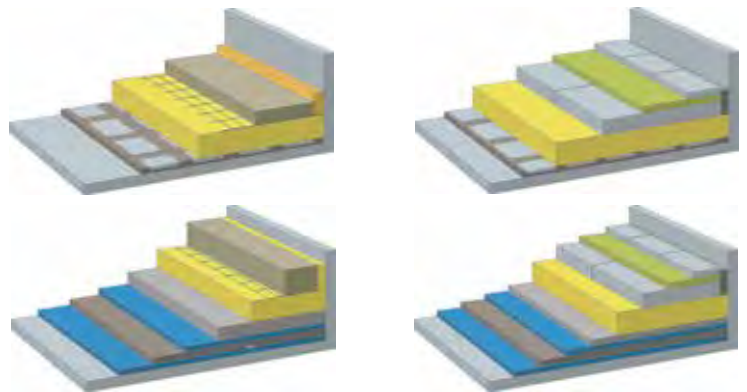

A-60 combinations with VEM 190

VEM 190 A-60 Combinations

Litosilo N
20 mm SeaRox

Litosilo X
20 mm SeaRox

Litosilo Steel
50 mm SeaRox

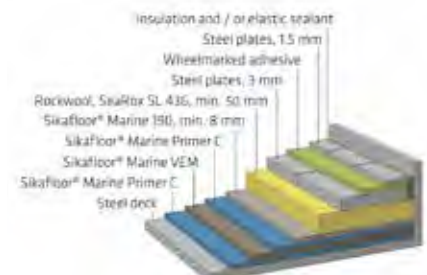
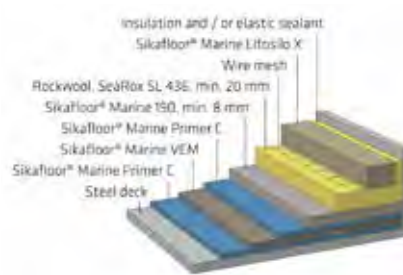
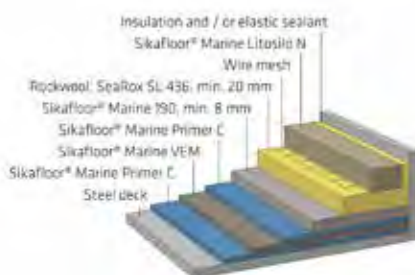

A-60 combinations with VEM Steel

VEM Steel A-60 Combinations

Litosilo N
20 mm SeaRox

Litosilo X
20 mm SeaRox

Litosilo Steel
50 mm SeaRox

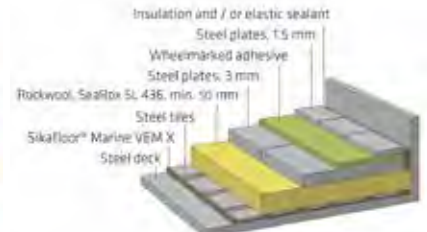
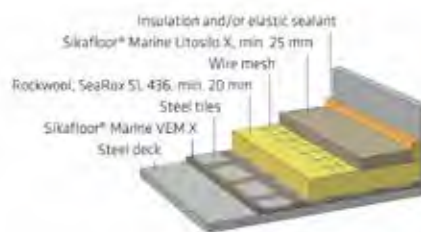
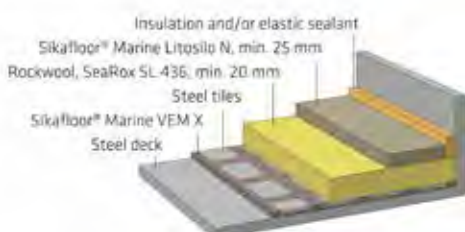

Sikafloor® Marine Systems

Visco-elastic systems/Green technology

VEM Green technology

Visco-elastic systems

- Extremely good vibration and damping properties
- Green technology
- 1-component, mortar water-based
- Isocyanate free
- The first well documented mortar visco
- VEM consumption app. 2 kg/m²
- No dangerous goods
- Less CO² because of less loads to be transported, less fuel consumption in the ships life time



Sikafloor® Marine VEM 118 FC:



Visco-elastic floor thickness: 11,5 mm
Weight: Approx. 20,0 kg/m²

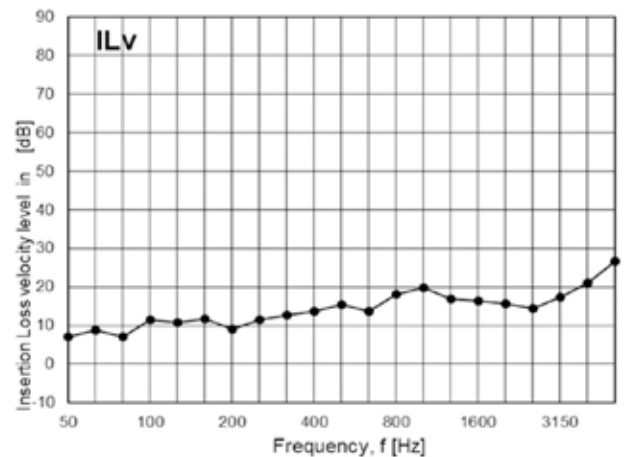

Sikafloor® Marine VEM Steel:

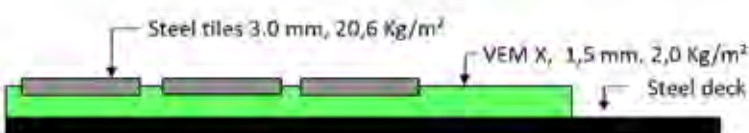

Visco floor min. thickness: 4,5 mm
Weight: Approx. 22,6 kg/m²

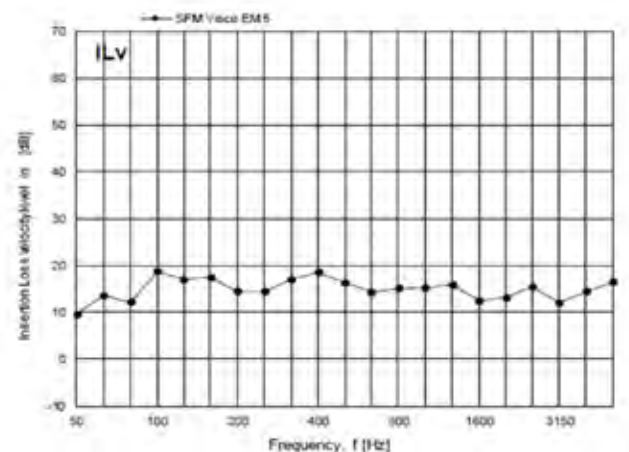

Sikafloor® Marine Systems

Visco-elastic



Sikafloor® Marine VEM

Visco-elastic system

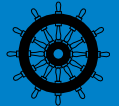

- Medium weight 1-component trowel out mortar
- Visco-elastic powder adhesive
- Primary deck covering
- Primer C is needed
- Density app. 1.3 kg/L
- Applicable up to 2 mm
- Walkable after 24 hours
- Water for mixing: 5,3 to 5,8L pr. 16 kg bag
- Application area: All wet and dry internal areas
- Material consumption: 1,3 kg/mm/m²

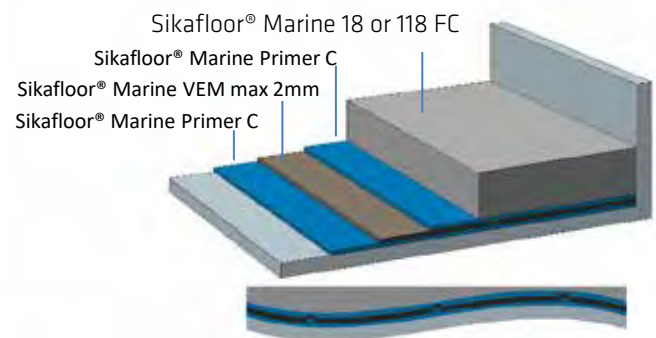

Sikafloor® Marine VEM X

Visco-elastic system



- Medium weight 1-component trowel out mortar
- Visco-elastic powder adhesive
- Primary deck covering
- No primer needed
- Density app. 1.3 kg/L
- Applicable up to 2 mm
- Walkable after 24 hours
- Water for mixing: 4,0 to 4,6L pr. 16 kg bag
- Application area: All wet and dry internal areas
- Material consumption: 1,3 kg/mm/m²

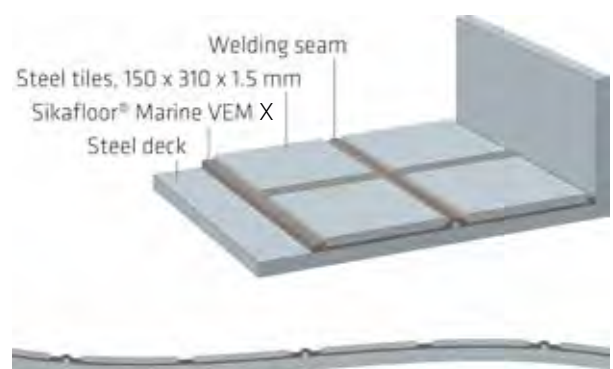

**EHS-FRIENDLY
TECHNOLOGY**

Sikafloor® Marine Systems

Visco-elastic

Sikafloor® Marine VEM 18

Visco-elastic system

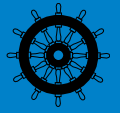

- VEM + SFM 18
- Primer C is needed
- Trowel out solution
- Leveling and visco in one go
- Not sensitive to deck straightness
- Weight from 12 to 23 kg/m² (depending on SFM 18 thickness)
- Material consumption VEM: 1,3 kg/mm/m²
- Material consumption SFM 18: 1,8 kg/mm/m²

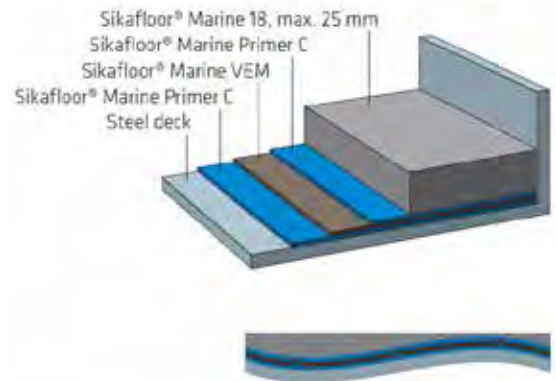

Sikafloor® Marine VEM 118 FC

Visco-elastic system



- VEM + SFM 118 FC
- Primer C is needed
- Self leveling fast curing solution
- Leveling and visco in one go
- Not sensitive to deck straightness
- Weight from 20 to 47 kg/m²
- Material consumption VEM: 1,3 kg/mm/m²
- Consumption SFM 118: 1,8 kg/mm/m²

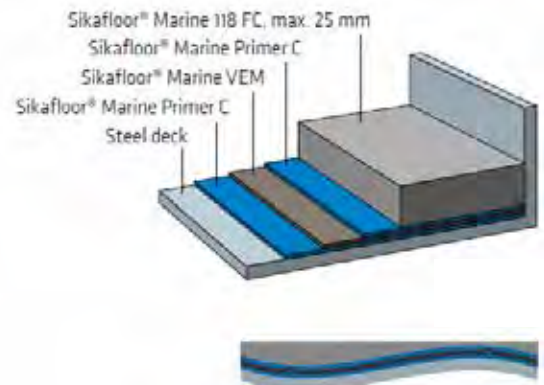

Sikafloor® Marine Systems

Visco-elastic

Sikafloor® Marine VES 515 Vertical visco-elastic system



- Acoustic underlay for vertical structure borne noise damping
- Sikaflex® 515 consumption app. 2 kg/m²
- Isocyanate and solvent free
- Silicone and PVC free
- Good vibration damping properties
- Steels plates are placed and pressed on the Sikaflex® 515
- To achieve the best damping properties, the steel plates need to be fully bonded to the structure
- The constrained layer has to cover min. 70 % of the area
- No mixing, studbolts or pre-application needed
- Very fast - immediate tack of the steel plates

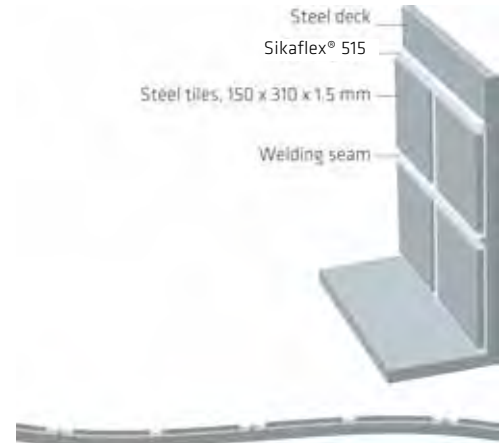

PU versus VEM technology

- The unique flexible, polymer modified VEM visco-elastic mortar system offers a 1-component water-based solution with no hazardous chemicals or dangerous goods handling
- VEM systems have the flexibility and the mass needed to dampen the vibrations of the vessel, especially in the lower frequency range produced by engines, thrusters and other noise sources
- VEM solutions are very competitive and environmental friendly

Comparison between the PU and new Sikafloor® Marine VEM technology in damping of structure borne noise, using the cement based visco-elastic system with the best demonstrated damping effect in the **low** frequencies.

Hz	PK-90N dB	VEM 1B dB	VEM 118 FC dB	VEM Steel dB
63	6.0	8.3	8.8	13.6
80	6.7	12.7	7.3	12.1
100	5.4	5.8	11.4	18.6
125	6.1	6.5	11.3	17.0
160	9.7	9.5	12.1	17.5
200	10.7	9.8	9.6	14.3
250	10.6	8.1	11.4	14.4
315	9.7	10.5	12.8	17.0
400	11.2	11.3	13.2	18.4
500	12.9	11.9	14.3	16.3
630	13.7	12.4	13.2	14.2
800	14.0	12.1	16.7	15.1
1000	13.9	13.1	18.0	15.2
1250	14.3	12.4	15.4	15.8
1600	14.1	13.9	13.5	12.5
2000	13.9	13.7	11.9	13.1
2500	14.6	13.7	11.9	15.4
3150	14.8	14.2	10.8	12.0
4000	15.2	14.0	16.7	14.4
5000	18.6	15.3	21.8	16.4

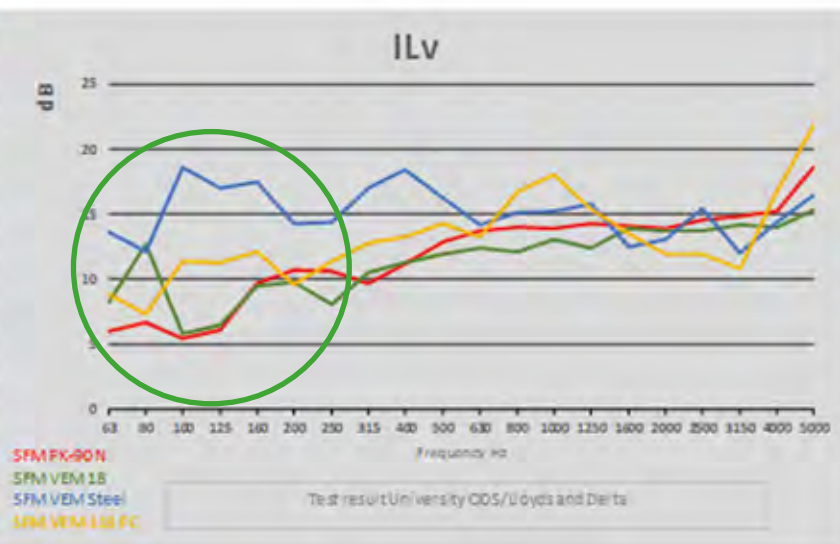

Sikafloor® Marine Systems

Elastic/Thermolight N

Sikafloor® Marine Elastic Waterproofing membrane



- Waterproofing membrane
- Density app. 1.4 kg/L
- Applicable up to 2 mm
- In case of application by roll always cross roll
- In case of porous underlay, always use first a diluted Primer C, otherwise pin holes will appear
- Material consumption: 1,4 kg/mm/m²
- As water seal in wet rooms, below ceramic tiles
- As water seal on floating floors

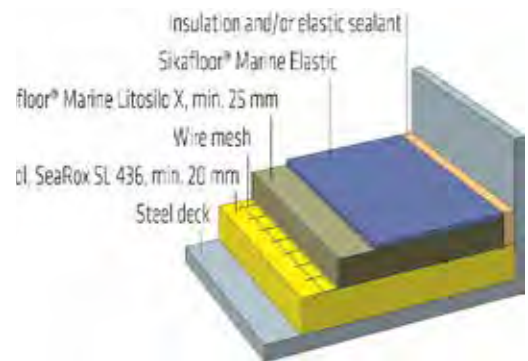

Sikafloor® Marine Thermolight N Ultra light weight leveling compound



- Ultra light weight leveling compound
- Density (SFM 120 + EP Balls) 0.58 g/cm³
- Density top layer 0.90 g/cm³
- Top layer is self leveling (SFM 120)
- Always use two layers of Primer C, between insulation and top layer
- Primer layer 1 Primer C diluted with 20 % water
- Primer layer 2 Primer C
- Material consumption insulation layer 16 kg SFM 120 + 48L light filler covers 1,6m² in 4 mm

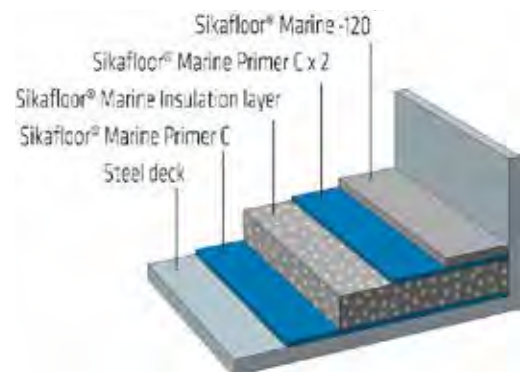

**SIKAFLOOR® MARINE SYSTEMS
- BUILDING TRUST**

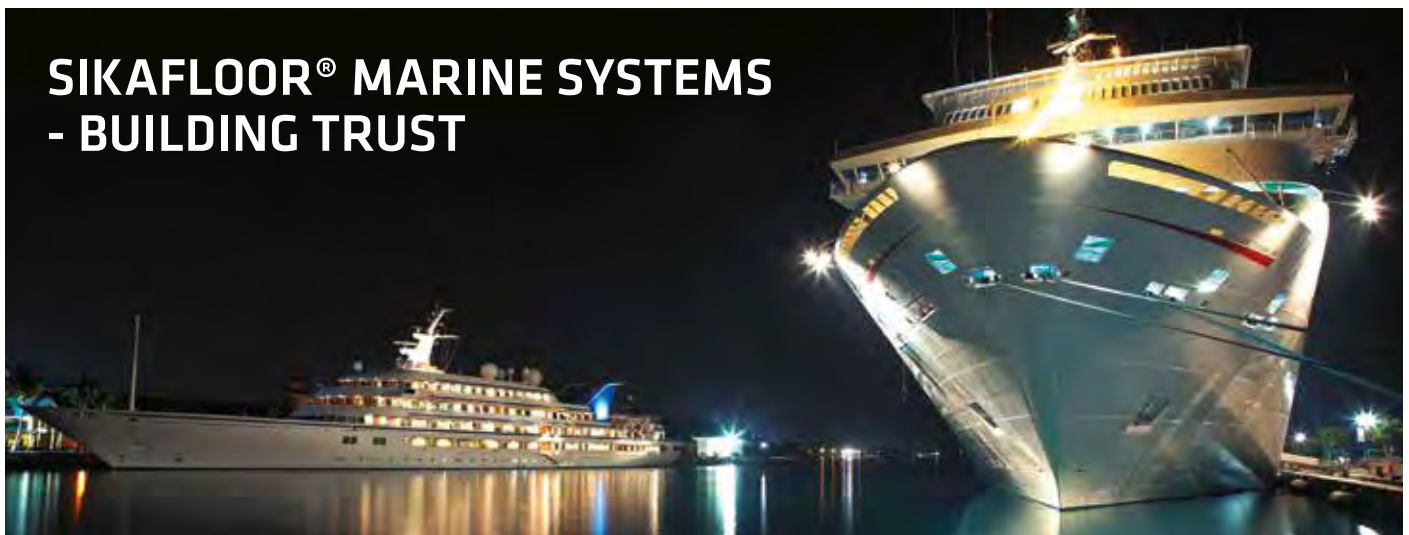

MARINE
Sikafloor® Marine
Primer C



Sikafloor® Marine Systems

Leveling products/Primer

Sikafloor® Marine Primer C

One primer for all cement based leveling products

- Water based (SBR)
- Adhesion promoter
- Steel decks
- Brush / Broom cleaned
- Between layers (2 coats 1 diluted and one pure)
- In case of Zinc rich shop primers or Alu deck, always use a tie-coat
- Please make sure it 100 % dry (transparent) before next layer
- Do not apply on loose rust
- Min. Deck temp 5° C
- In case of application on absorbent underlay use two primer layers, to prevent bubbles
- Primer 1, Primer C, diluted with 20 % water
- Primer 2, Primer C, not diluted



- Application
- Showing a blue milk color

- Ready for use - transparent and dry (approx. 30 min. after application depending on temperature and ventilation)





MARINE Sikafloor® Marine decorative floors

Sikafloor® Marine Systems has gained a world-wide experience in the field of deck coverings on commercial vessels, yachts, and cruise ships. Our decking systems are proven to be the best in class due to factors such as ease of installation, low weight, improvements in acoustics and superior aesthetics.

Sika is launching a new range of specially designed IMO certified interior and exterior decorative flooring systems. With Sikafloor® Marine Deco Comfort there are no limits for the creative mind, the system is available in almost every colour, and can be combined with aesthetical additives and different colours can easily be mixed-and-matched together.

Sikafloor® Marine Deco Systems

Interior and exterior flooring systems

Sikafloor® Marine decorative floors

Interior/Exterior



Sikafloor® Marine Decorative Range

AREA	APPLICATION	DESCRIPTION/AREAS	SYSTEM
INTERIOR	UTILITY EPOXY	WORKING AND WET AREAS – LAUNDRY – GALLEY – WET CORRIDORS – SAUNA, MACHINERY – RAMPS, CORRIDORS	Sikafloor® Marine Deco Epoxy – Broadcasted – Smooth
	DECORATIVE EPOXY		
	DECORATIVE PU	– PUBLIC AREAS – CORRIDORS – CABINS – SUN PROTECTED AREAS – CASINO/HOSPITAL/GYM	Sikafloor® Marine Deco Comfort



Sikafloor® Marine Decorative Range

AREA	APPLICATION	DESCRIPTION/AREAS	SYSTEM
EXTERIOR	TEAK IMITATION PU	– CORRIDORS – POOL AREAS – SOLARIUM – BALCONIES – OPEN/ PROTECTED AREAS	Sikafloor® Marine Deco Teak
	TRUE COLORS	– CORRIDORS – POOL AREAS – SOLARIUM – BALCONIES – OPEN AND PROTECTED AREAS – SPORTS FLOORS – HELIPADS / HEAVY DUTY	Sikafloor® Marine Deco Hard

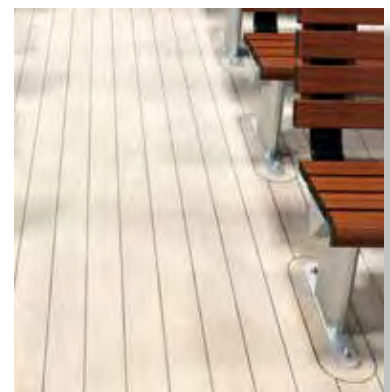

Sikafloor® Marine Deco Systems

Interior and exterior flooring systems

Sikafloor® Marine Deco Comfort



Sikafloor® Marine Deco Comfort is a unique, comfortable, very elastic and highly decorative polyurethane resin floor. The floor system offers excellent grip in both dry and wet conditions.

The smooth and seamless design makes it an ideal alternative to sheet vinyl finishes. Sikafloor® Marine Deco Comfort system consists of multiple primers, leveling materials, base and topcoats which are all accompanied with the necessary IMO certification.

The Sikafloor® Marine Deco Comfort is resistant to the most common oils, greases, juices, salts and solvents. Due to its flexibility, Sikafloor® Marine Deco Comfort systems do not break, crack or splinter and are easy to clean and require low maintenance.

- Self-smoothing
- Very low VOC emission
- Flexible with good crack bridging capability
- Foot warm
- Permanently elastic
- Good mechanical resistance
- Easy to apply
- IMO certified
- Easy to maintain

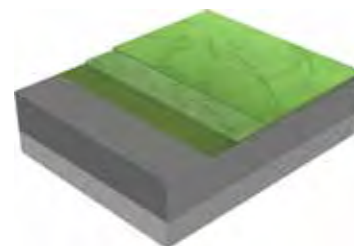

Layer	Product
1. Substrate	Steel deck
2. Substrate	Leveling compound
3. Primer	Sikafloor®-161 /-156
4. Base coat:	Sikafloor® Marine-530/-570 /-590
5. Top coat:	Sikafloor® Marine-504/-505



Kitchen and wetrooms



Sanitary units



Galleys and cafeterias



Hospital areas

Sikafloor® Marine Deco Teak



The Sikafloor® Marine Deco Teak systems have already proven to be amongst the best in class products due to their ease of installation, low weight, better acoustical performance, excellent aesthetics and comfort. Sikafloor® Marine Deco Teak can be applied as a prefabricated solution which opens the door widely for playful designs and the implementation of logo's in the synthetic deck.

- Ease of workability
- Very low VOC emission
- Solvent free
- Low density
- Permanently elastic
- Good crack bridging properties
- Seamless
- Easy to clean and maintain
- Very long service life
- Multiple deck colours
- Multiple caulking colours



Sikafloor® Marine Deco Systems

Interior and exterior flooring systems - PREFAB

Sikafloor® Marine Deco Teak

Prefab application

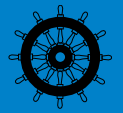

- Ease of workability
- Very low VOC emission
- Solvent free
- Low density
- Permanently elastic
- Good crack bridging properties
- Seamless
- Easy to clean and maintain
- Very long service life
- Multiple deck colours
- Multiple caulking colours

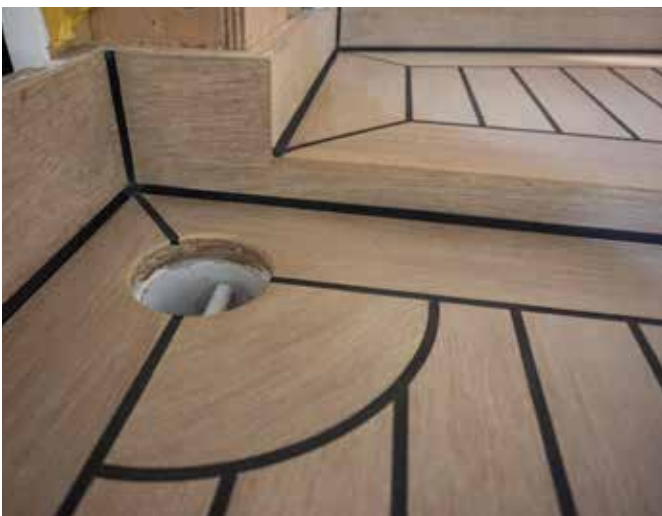
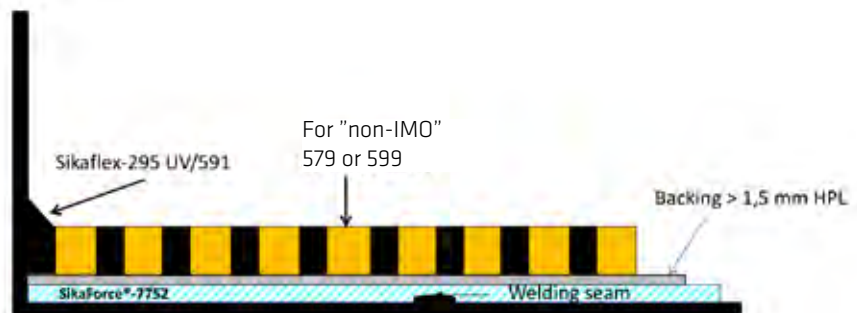

Sikafloor® Marine Deco Systems

Interior and exterior flooring systems

Sikafloor® Marine-530

Interior



- 2-component, very low VOC, polyurethane, high aesthetical flooring system for interior use
- Soft, elastic and comfortable
- IMO certification
- Can be used as caulking material for SFM Deco Teak - Black only
- Primer - Sikafloor® Marine Primer C
- Leveling - Sikafloor® Marine leveling mortars
- Sikafloor® Marine 161/156 or similar epoxy primer
- Deco layer - Sikafloor® Marine-530/-570 decorative Floor
- Topcoat - Sikafloor® 505 /504

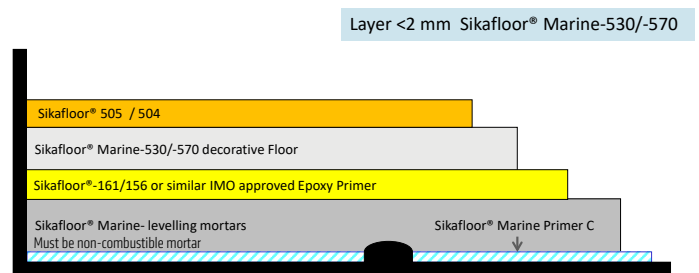

Sikafloor® Marine-570/-590

Exterior



- 2-component, very low VOC, polyurethane, aesthetical flooring system
- Tough, semi-elastic, with mechanical resistance
- IMO certification
- Primer - Sika® Cor ZP Primer
- Leveling - Sika® Transfloor-352 ST / SL / VSL / 530 + Fillers
- Deco layer - Sikafloor® Marine-570 / 579 / 590 / 599
- Caulking - Sikafloor® Marine-590 or 530 black

Deco teak application stages

- Phase 1 - Substrate preparation
- Phase 2 - Priming
- Phase 3 - Deck leveling layer and sanding
- Phase 4 - Decorative coloured layer
- Phase 5 - Cutting the caulking joints & caulking application
- Phase 6 - Pre- sanding
- Phase 7 - Final sanding
- Phase 8 - Sealing (yes and no)
- Phase 9 - Maintenance regime

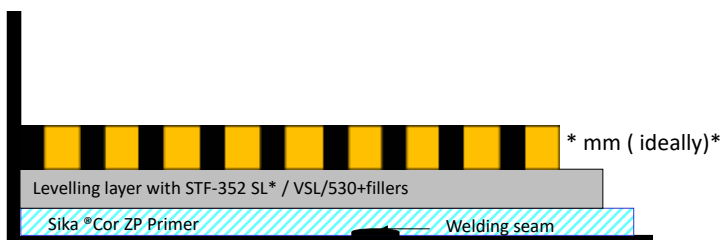

Sikafloor® Marine Deco Systems

Exterior systems - Teak

Sikafloor® Marine-570 Color design for passenger ships



Desert Sunrise
21887



Britisch Pearl
99203



Antique Brass
82494



Obregon Olive
99204



Arizona Almond
99202



Colors may vary slightly.

Sikafloor® Marine-590 Color design for super yachts



Iceland
99078



Sahara
99081

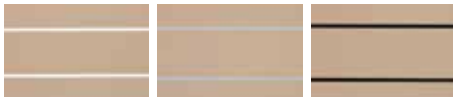

Burma
99079



Tasmania
99086



Havana
99093

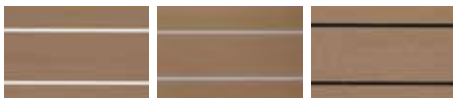

Tuscany
99201



Macau
99088



Sicily
99085

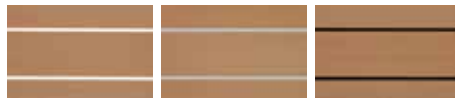

Yucatan
99200



Manaos
99082

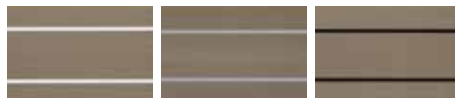

Colors may vary slightly.

Sikafloor® Marine Deco Systems

Epoxy

Sikafloor® Marine Deco Epoxy

Lay up epoxy quartz

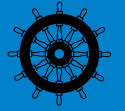

- Primer - Sikafloor® Marine Primer C
- Leveling - Sikafloor® Marine leveling mortars
- Primer - Sikafloor® Marine 161/156 or similar epoxy primer
- Body layer - Sikafloor® Marine 264 + Filler
- Seal coat - Sikafloor® Marine 609
- Topcoat - Sikafloor® Marine 504 (optional)

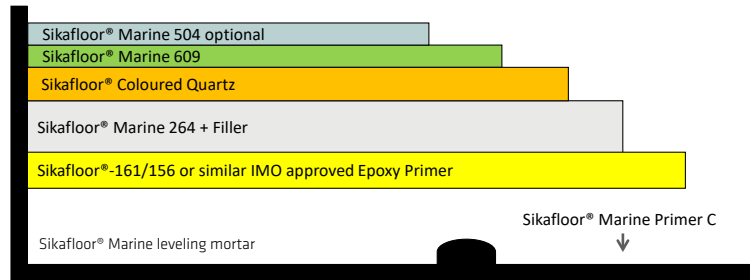

Sikafloor® Marine Deco Epoxy

Lay up epoxy smooth and flaked

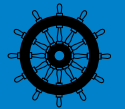

- Primer - Sikafloor® Marine Primer C
- Leveling - Sikafloor® Marine leveling mortars
- Primer - Sikafloor® Marine 161/156 or similar epoxy primer
- Body layer - Sikafloor® Marine 264 + Filler
- Sika Color Flake
- Topcoat - Sikafloor® Marine 504

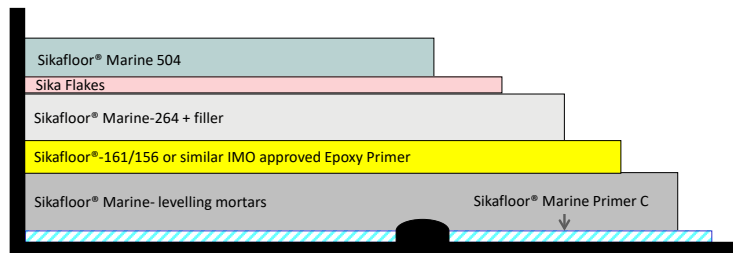

Sikafloor® Marine Deco Epoxy

Lay up epoxy broadcast



- Primer - SikaCor® ZP Primer
- First coat - Sikafloor® Marine 264
- Sika Color Flakes
- First coat - Sikafloor® Marine 264

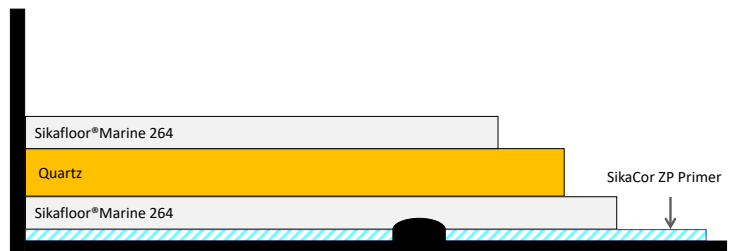

Sikafloor® Marine Deco Systems

RAL-codes/Teak decking application guide

RAL-codes Unlimited colour

RAL 1000	RAL 1001	RAL 1002	RAL 1003	RAL 1004	RAL 1005	RAL 1006	RAL 1007
RAL 1011	RAL 1012	RAL 1013	RAL 1014	RAL 1015	RAL 1016	RAL 1017	RAL 1018
RAL 1029	RAL 1030	RAL 1031	RAL 1032	RAL 1033	RAL 1034	RAL 1035	RAL 1036
RAL 1037	RAL 1038	RAL 1039	RAL 1040	RAL 1041	RAL 1042	RAL 1043	RAL 1044
RAL 2001	RAL 2002	RAL 2003	RAL 2004	RAL 2005	RAL 2006	RAL 2007	RAL 2008
RAL 3001	RAL 3002	RAL 3003	RAL 3004	RAL 3005	RAL 3006	RAL 3007	RAL 3008
RAL 4001	RAL 4002	RAL 4003	RAL 4004	RAL 4005	RAL 4006	RAL 4007	RAL 4008
RAL 5001	RAL 5002	RAL 5003	RAL 5004	RAL 5005	RAL 5006	RAL 5007	RAL 5008
RAL 6001	RAL 6002	RAL 6003	RAL 6004	RAL 6005	RAL 6006	RAL 6007	RAL 6008
RAL 7001	RAL 7002	RAL 7003	RAL 7004	RAL 7005	RAL 7006	RAL 7007	RAL 7008
RAL 8001	RAL 8002	RAL 8003	RAL 8004	RAL 8005	RAL 8006	RAL 8007	RAL 8008
RAL 9001	RAL 9002	RAL 9003	RAL 9004	RAL 9005	RAL 9006	RAL 9007	RAL 9008
RAL 1009	RAL 1010	RAL 1011	RAL 1012	RAL 1013	RAL 1014	RAL 1015	RAL 1016
RAL 1017	RAL 1018	RAL 1019	RAL 1020	RAL 1021	RAL 1022	RAL 1023	RAL 1024
RAL 6009	RAL 6010	RAL 6011	RAL 6012	RAL 6013	RAL 6014	RAL 6015	RAL 6016
RAL 6017	RAL 6018	RAL 6019	RAL 6020	RAL 6021	RAL 6022	RAL 6023	RAL 6024
RAL 6025	RAL 6026	RAL 6027	RAL 6028	RAL 6029	RAL 6030	RAL 6031	RAL 6032
RAL 6033	RAL 6034	RAL 6035	RAL 6036	RAL 6037	RAL 6038	RAL 6039	RAL 6040
RAL 7009	RAL 7010	RAL 7011	RAL 7012	RAL 7013	RAL 7014	RAL 7015	RAL 7016
RAL 7017	RAL 7018	RAL 7019	RAL 7020	RAL 7021	RAL 7022	RAL 7023	RAL 7024
RAL 7025	RAL 7026	RAL 7027	RAL 7028	RAL 7029	RAL 7030	RAL 7031	RAL 7032
RAL 7033	RAL 7034	RAL 7035	RAL 7036	RAL 7037	RAL 7038	RAL 7039	RAL 7040
RAL 7041	RAL 7042	RAL 7043	RAL 7044	RAL 7045	RAL 7046	RAL 7047	RAL 7048
RAL 7049	RAL 7050	RAL 7051	RAL 7052	RAL 7053	RAL 7054	RAL 7055	RAL 7056
RAL 8009	RAL 8010	RAL 8011	RAL 8012	RAL 8013	RAL 8014	RAL 8015	RAL 8016
RAL 8017	RAL 8018	RAL 8019	RAL 8020	RAL 8021	RAL 8022	RAL 8023	RAL 8024
RAL 8025	RAL 8026	RAL 8027	RAL 8028	RAL 8029	RAL 8030	RAL 8031	RAL 8032
RAL 8033	RAL 8034	RAL 8035	RAL 8036	RAL 8037	RAL 8038	RAL 8039	RAL 8040
RAL 9009	RAL 9010	RAL 9011	RAL 9012	RAL 9013	RAL 9014	RAL 9015	RAL 9016
RAL 9017	RAL 9018	RAL 9019	RAL 9020	RAL 9021	RAL 9022	RAL 9023	RAL 9024
RAL 9025	RAL 9026	RAL 9027	RAL 9028	RAL 9029	RAL 9030	RAL 9031	RAL 9032
RAL 9033	RAL 9034	RAL 9035	RAL 9036	RAL 9037	RAL 9038	RAL 9039	RAL 9040

Sikafloor® Marine Deco epoxy & polyurethane

Unlimited colour possibilities!

Sika Teak decking application guide

Teak deck covering

Please find a separate application guide regarding teak decking.

Leveling, bonding and caulking of teak decks:

- Surface preparation
- Deck leveling
- Deck bonding and bedding
- Deck caulking
- Prefabricated teak decks
- Maintenance of teak decks
- Teak deck repair
- Alternatives to teak
- Bonding of timber elements



MARINE

Sealing and bonding technology

Discover our Sikaflex range that accompanies you aboard the boat in various applications. Widely used in the construction of many ships, from yacht to liner, from trawler to supertanker, the Sika Marine range ensures multiple maintenance and maintenance operations throughout their working lives.

Sikaflex adhesives and sealants make it possible to make flexible, perfectly waterproof and resistant assemblies between a large numbers of materials. They can be used with confidence above and below the waterline and are for the most part approved by the certifying bodies and authorized to carry the "Wheelmark".



Sikaflex®

1K-Polyurethan sealing and bonding

Sikaflex®-290 DC PRO

The professional deck caulking sealant



The Sikaflex®-290 DC PRO is a specifically designed sealing compound for teak decks, and can take care of all your boat caulking needs. Sikaflex®-290 DC PRO's innovative formula is also suitable for particularly exposed joints, such as shipbuilding gaskets. Specifically designed for the caulking of teak decks, Sikaflex®-290 DC PRO provides anti-slip properties to bridges, even when wet.

- Excellent Ageing and weathering resistance
- Easy to sand Durable joints
- Excellent resistant to sea water
- Soft



Sikaflex®-291i

Multi-purpose adhesive

Sikaflex®-291i is a practical, easy-to-use multi-purpose adhesive with less waste. Sikaflex®-291i is the perfect solution for common repairs and the regular maintenance of boats. Its applications include creating flexible seals resistant to strong vibrations, the installation of fittings (fans, hatches, etc.), and various adhesive applications (lamination, strakes, rods, elements of interior arrangement, etc.).

- Ideal for sealing
- Resistant to vibrations
- Good resistance to sea water
- Good adhesion to a majority of fittings
- Can be sanded and painted



Sikaflex®-292i

High-strength fastening adhesive for structural assembly



Sikaflex®-292i is a high-strength fastening adhesive perfectly suited for structural joints subjected to high dynamic stresses (hulls, fastenings of deck fittings on the hull, etc.), high mechanical stresses (shocks, tearing), and climate (bad weather, salt). Sikaflex®-292i ensures a high strength fastening without degrading the support.

- Resistant to high dynamic stresses
- Compensates for the irregularities of the supports
- Good adhesion on a wide range of supports
- Can be applied to thick joints (filling of interstices)
- Can be painted



Sikaflex®

1K-Polyurethan sealing and bonding

Sikaflex®-295 UV

High-performance bonding and glazing sealant



Sikaflex®-295 UV is a bonding and glazing sealant specifically developed for the marine industry. It is designed for application on organic glass such as PC or PMMA. Sikaflex®-295 UV has excellent UV resistance, facilitating the production of particularly exposed joints. Sika recommends the use of Sikaflex®-295 UV for bonding and sealing windows and portholes.

- Excellent resistance to weathering, UV rays and aging
- Does not spin
- Fast curing time
- Ideal for organic glazing



Sikaflex®-296

Adhesive for mineral glass



Sikaflex®-296 is a 1-component polyurethane accelerator specifically designed for bonding mineral glass.

- 1-component
- Excellent processing characteristics
- Fast curing time
- Excellent ageing resistance
- Solvent and PVC free
- Can be applied without a primer



Sikaflex®-298 FC

Adhesive for full-surface bonding



Sikaflex®-298 FC is a 1-component polyurethane adhesive based on the latest polyurethane i-Cure technology. It is specifically designed for full-surface bonding for synthetic resin linings, and is also suitable for sealing teak planks on bridges. This product is not intended for caulking teak decks.

- Dampens noise and vibration
- Suitable for large working areas
- Long open time
- Flexible
- Solvent-free
- Soft - floats easily



Sikaflex®

1K-Polyurethan sealing and bonding

Sikaflex® -591

Multifunctional sealants



Sikaflex®-591 is a multifunctional sealant based on Sika's Silane Terminated Polymer (STP) technology. It is suitable for elastic, vibration-resistant joint seals. With its excellent resistance against the harsh maritime weathering conditions Sikaflex®-591 can be used for a wide range of applications for a wide variety of interior and exterior sealing applications. Sikaflex®-591 bonds well to substrates commonly used in the marine industry.

- Highly elastic
- Excellent weathering stability
- Compatible with non-ferrous metals
- Free of isocyanate, solvents, PVC, phthalates and tin catalysts
- Very good processing and tooling characteristics
- Bonds well to a wide variety of marine substrates



Sikasil®

Industri silicone

Sika Firesil® Marine N Fire resistant silicone sealant



General purpose sealant for applications requesting fire resistance according to DIN 4102 B1 and as sealing of gaps, cable ducts, grommets etc. where compliance with IMO 653 (16) is required.

- Versatile, suitable for use in movement and non-movement joints, in construction and industrial applications
- Excellent temperature insulation
- Suitable for interior and exterior applications
- One-part formulation
- Elastic
- Resists ageing and weathering
- High fire resistance
- Bonds well to a wide variety of substrates



Sikasil® SG-20 High-performance neutral silicone sealant



Sikasil® SG-20 is a high-performance glazing sealant specifically developed for bonding and glazing. It can be applied on organic glass such as PC or PMMA. Sikasil® has excellent UV resistance, facilitating the production of particularly exposed joints.

- Excellent resistance to weather, UV-rays and ageing
- Odorless
- Neutral polymerization
- Can be applied without primer
- Recommended for organic glazing



Sikasil® WS-605 S High-performance weatherproofing sealant



Sikasil® WS-605 S is a durable, neutral-curing silicone sealant with a high movement capability and excellent adhesion to a wide range of substrates.

- Outstanding UV and weathering resistance
- Does not stain areas adjacent to the joint
- Adheres well to glass, metals, coated / painted metals, plastics and wood





Product selection guide/ Produktveileder - hva brukes hvor?

SIKA MARINE - DET PROFESJONELLE VALG PRODUKTVEILEDER - HVA BRUKES HVOR?

- = Beste løsning
- = God løsning
- = Mulig løsning

Sikaflex®-591

Sikaflex®-292i

Sikasil® WS-605 S

Sikaflex®-295 UV

Sikaflex®-296

SikaFiresil® Marine N

Sikaflex®-290 DC

Sikaflex®-298

LIM OG INNFESTING

	Sikaflex®-591	Sikaflex®-292i	Sikasil® WS-605 S	Sikaflex®-295 UV	Sikaflex®-296	SikaFiresil® Marine N	Sikaflex®-290 DC	Sikaflex®-298
Generell liming	●●	●●●						
Liming av skrog og flybride		●●●						
Liming av fenderlister		●●●						
Liming av deksler etc.	●●							●●●



TEAKDEKK

	Sikaflex®-591	Sikaflex®-292i	Sikasil® WS-605 S	Sikaflex®-295 UV	Sikaflex®-296	SikaFiresil® Marine N	Sikaflex®-290 DC	Sikaflex®-298
Liming av teakdekk								●●●
Nating av teakdekk							●●●	



LIMING AV RUTER/VINDUER

	Sikaflex®-591	Sikaflex®-292i	Sikasil® WS-605 S	Sikaflex®-295 UV	Sikaflex®-296	SikaFiresil® Marine N	Sikaflex®-290 DC	Sikaflex®-298
Mineralglass					●●●			
Organisk glass, eks. Plexi				●●●	●			



FUGING OG TETTING

	Sikaflex®-591	Sikaflex®-292i	Sikasil® WS-605 S	Sikaflex®-295 UV	Sikaflex®-296	SikaFiresil® Marine N	Sikaflex®-290 DC	Sikaflex®-298
Interiørfuging	●●●							
Eksteriørfuging	●●●		●●●	●●●				
Overmalbar fug	●●●	●						
Brannhemmende fugemasse						●●●		
Sanitærfuging	●●							
Fuging av ikke-jernholdige metaller	●●●							

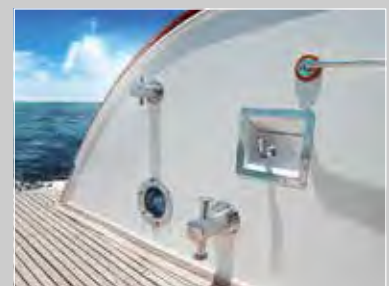

For forbehandling av overflater, se Sika marine forbehandlingstabell.

Primer

Sika® Primer-290 DC

Primer for bonding and sealing timber decking strips

Sika® Primer-290 DC is a transparent, pale yellow, low viscosity liquid that cures by reaction with atmospheric moisture. It is used to prime timber decking strips prior to caulking with Sikaflex®-290 DC or bonding with Sikaflex®-298.

Sika® Primer-290 DC is manufactured in accordance with ISO 9001 / 14001 quality assurance system and the responsible care program.

Sika® Primer-290 DC is formulated for use on the following substrates:

- Teak
- Mahogany
- Oregon pine
- Cork
- GRP based on polyester



Sika® MultiPrimer Marine

Multi-purpose solvent primer

Sika® MultiPrimer Marine is a liquid primer specific designed to improve the adhesion of Sikaflex® products to various substrates such as wood (teak, mahogany, Oregon pine and cork), metals (aluminum, galvanized steel sheets), GRP and other plastics, and primed substrates. It is also a suitable primer of Sikasil® adhesives and sealants on porous and non-porous substrates.

- Easy to apply
- Increases adhesion of Sikaflex® and Sikasil® on various substrates
- Long open time
- Thermoplastic behavior
- Low odor
- Allows homogenization of surface preparation on varying substrates
- Sika® MultiPrimer Marine offers reliability, high bonding strength, durability and convenient workability. The material can be used in conjunction with the following Sika Marine sealants and adhesives: Sikaflex-291i/ -292i/ -295 UV/ -298 FC/ -290i DC and Sikaflex 591.



Sika® Primer-206 G+P

Pigmented, solvent-based primer for various substrates

Sika® Primer-206 G+P is a solvent-based black primer which reacts with moisture and forms a thin layer. This layer acts as a link between substrates and adhesives. Sika® Primer-206 G+P is specifically formulated for the treatment of bond faces prior to application of Sika's 1-component Polyurethanes.



Primer

Sika® Primer-207

Pigmented, solvent-based primer for various substrates

Sika® Primer-207 is a solvent-based black primer, which reacts with moisture and forms a thin layer. This layer acts as a link between substrates and adhesives. Sika® Primer-207 is specifically formulated for the treatment of bond faces prior to application of Sika's 1-component Polyurethanes.

Sika® Primer-207 is used to improve adhesion on a very broad range of different substrates such as float glass, ceramic-coated glass, plastics, pre-coatings, painted surfaces, E-coats and metals.



Sika® Primer-209 D

Polyurethane-based black primer

Sika® Primer-209 D is a black, moisture-curing low viscosity primer specifically formulated for the treatment of painted surfaces or plastics prior to the application of Sikaflex® direct-glazing adhesive.



Aktivator

Sika® Aktivator-100

Adhesion promoter for various substrates

Sika® Aktivator-100 is an activating agent to improve adhesion. It is specifically formulated for the treatment of bond faces prior to application of various Sika polyurethane adhesives.



Sika® Aktivator-205

Pre-treatment agent for non porous substrates

Sika® Aktivator-205 is an alcohol solution containing a bond-activating substance designed for the activation of surfaces prior to bonding and sealing with Sika® products. Sika® Aktivator-205 is manufactured in accordance with ISO 9001 / 14001 quality assurance system and with the responsible care program.



Cleaner/Remover

Sika® Remover-208

Sika® Remover-208 is used to remove traces of Sikaflex® products as well as for cleaning painted substrates. Sika® Remover-208 is manufactured in accordance with ISO 9001 / 14001, quality assurance system and with the responsible care program.

Sika® Remover-208 can be used to remove uncured excess Sikaflex® adhesive or sealant from application tools or soiled surfaces. Sika® Remover-208 can also be used for pre-cleaning strongly contaminated non-porous substrates. Sika® Remover-208 can be used to clean painted surfaces prior to bonding. Use Sika® Remover-208 according to the Sika Pre-treatment Chart.



Sika® Cleaner P

Cleaning agent for non porous substrates

Sika® Cleaner P is a low-viscosity, solvent-based cleaning agent for non porous substrates. Sika® Cleaner P is manufactured in accordance with ISO 9001 quality assurance system and the responsible care program.

Sika® Cleaner P can be used to remove foreign matter and contaminants, such as grease, oil, dust and dirt from the surface of, for example, plastics, polyester powder-coated metals and PVDF-coated metals prior to the application of sealants and adhesives. Sika® Cleaner P is also suitable for cleaning glass and metal surfaces. It should only be used on non-porous substrates.



Sika® Handclean

Cleaning cloths

Apart from normal dirt and soils, Sika® Handclean will remove heavy-grease, lubricants, adhesives, oils, tar, inks, wax and many other difficult to remove soils such as coal dust, graphite and grass stains, etc

- Cloths impregnated with a high performance, liquid and cleaning formula
- Time saving: Cleaning direct at workplace
- Fast cleaning of machines, tools and accessories



Cleaner

Sika® Tooling agent N, 1 liter

Sika® Tooling Agent N is a waterbased, solvent-free tooling agent for Sikaflex® products.

- Neutral
- Non aggressive to skin
- Does not attack paints (even water-based)
- No washing-out or etching of fresh applied sealants or adhesives



Sika® Cleaner PCA

Sika® Cleaner PCA is a smart cleaning pad based on melamine foam. It is used for removal of contamination or cleaning of windshields and other surfaces. Additionally it can be used to apply Sika® Primer. Sika® Cleaner PCA is designed for the removal of contamination on ceramic frits or glass. It can also be used for the removal of label residues and other kinds of pollution. Sika® Cleaner PCA is well suited to apply Sika® Primers used in the Auto Glass Replacement business.



A photograph of a sailboat on the ocean. The top right corner shows a white sail with a grid pattern. The rest of the image shows the blue sea with white foam from the boat's wake. The sky is light blue with some clouds. The text is overlaid on the upper left portion of the image.

MARINE Application guide

Since the middle of the 17th century, when the industrial revolution began, the process of manufacture has changed dramatically, in methods and materials. At the time, it was state-of-the-art to assemble boats and ships using traditional methods like wood jointing, nailing and screwing. Riveting and welding followed in later years, but today, we are aware of the limitations of these old methods compared to what is currently available.

New lightweight materials as well as sandwich structures need smooth, stress concentration free assembly. Today, time, weight, cost, design freedom and reliability are all greatly enhanced by using chemical bonding, sealing and damping products.



Adhesive primer consumption

DESIGN OF ADHESIVE LAYER GEOMETRY

The elastic adhesive can only fully develop its positive properties (movement compensation, peeling and impact resistance) if the adhesive layer geometry is correct.

Above all, this means keeping to a minimum layer thickness that must be individually suited to the bond. A layer thickness of 2-3 mm has proved best for most applications. Thicker layers may be required where considerable movement is expected.

Depths over 20 mm should be avoided with standard Sikaflex® grades because the adhesive would take too long to harden.

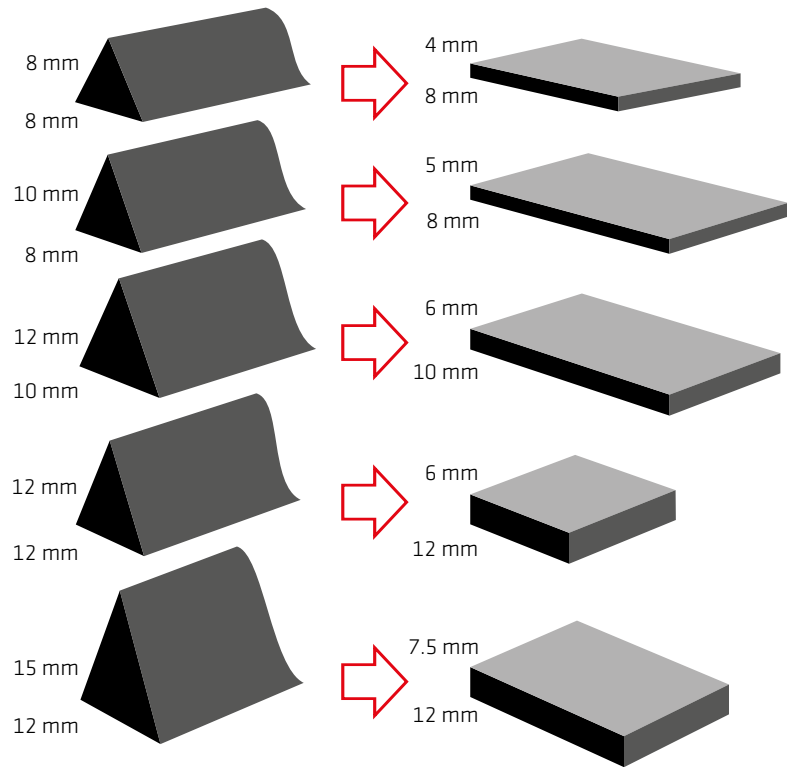

	JOINT WIDTH	NO. OF METRES PER 300 ML CARTRIDGE			NO. OF METRES PER 100 ML TUBE		
		5	10	15	5	10	15
DEPTH / LAYER THICKNESS OF BOND (MM)	1	62.00	31.00	20.60	20.00	10.00	6.60
	2	31.00	15.50	10.30	10.00	5.00	3.30
	3	20.60	10.30	6.88	6.60	3.30	2.20
	4	15.50	7.75	5.15	5.00	2.50	1.60
	5	12.40	6.20	4.10	4.00	2.00	1.30
	6	10.30	5.16	3.44	3.30	1.60	1.10
	7	8.85	4.40	2.95	2.80	1.40	0.90
	8	7.75	3.90	2.60	2.50	1.20	0.80
	9	6.90	3.50	2.30	2.20	1.10	0.70
	10	6.20	3.10	2.00	2.00	1.00	0.60

PRIMER AND CLEANER CONSUMPTION

PRODUCT	YIELD PER 100 ML AT 20 MM WIDTH (m)	BRUSH APPLICATION TISSUE APPLICATION* (l / m²)
Sika® Aktivator / Sika® Aktivator-205	25-30	0.04*
Sika® Primer-206 G+P	17-22	0.1-0.15
Sika® Primer-209 D	12-15	0.15-0.2
Sika® MultiPrimer Marine	12-15	0.15-0.2

Make sure that:

- The primed areas coincide with the bonding areas
- The right primer for the material surface is used
- The primer is completely dry and cured before bonding i.e. watch the evaporation time
- Primers are shaken if necessary

Conversions and calculations

FORMULAE

TO ESTIMATE THE NUMBER OF LITRES REQUIRED

Normal bead application;

$$\text{Quantity in litres} = \frac{\text{bead width (mm)} \times \text{bead thickness (mm)} \times \text{joint length (metres)}}{1000}$$

(Dimensions are for wet adhesive in rectangular cross section)

Large area bonding and laminating;

$$\text{Quantity in litres} = \text{width (metres)} \times \text{length (metres)} \times \text{wet film adhesive thickness (mm)}$$

TO DETERMINE THE VOLUME OF A SEMI-CIRCULAR BEAD

$$\text{Quantity in litres} = \frac{3.142 \times \text{diameter (mm)} \times \text{diameter (mm)} \times \text{length (metres)}}{8000}$$

TO DETERMINE THE VOLUME OF A TRIANGULAR BEAD

$$\text{Quantity in litres} = \frac{\text{width (mm)} \times \text{height (mm)} \times \text{length (metres)}}{2000}$$

TO CONVERT KILOGRAMS TO LITRES

$$\text{Quantity in litres} = \frac{\text{weight in kilograms}}{\text{density (grams / ml or kg / l)}}$$

TO CONVERT BETWEEN TEMPERATURE SCALES

$$\text{Fahrenheit} = \frac{(\text{degrees celsius (}^\circ\text{C)} \times 5)}{9} - 32$$

$$\text{Celsius} = \frac{(\text{degrees fahrenheit (}^\circ\text{F)} \times 9)}{5} + 32$$

The information, and, in particular, the recommendations relating to the application and end-use of Sika products, are given in good faith based on Sika's current knowledge and experience of the products when properly stored, handled and applied under normal conditions. In practice, the differences in materials, substrates and actual site conditions are such that no warranty in respect of merchantability or of fitness for a particular purpose, nor any liability arising out of any legal relationship whatsoever, can be inferred either from this information, or from any written recommendations, or from any other advice offered.

The proprietary rights of third parties must be observed. All orders are accepted subject to our current terms of sale and delivery. Users should always refer to the most recent issue of the Sika Product Datasheet for the product concerned, copies of which will be supplied on request.

TEMPERATURE SCALES		
°C		°F
100		212
80		176
60		140
40		104
35		95
30		86
25		77
20		68
15		59
10		50
5		41
0		32

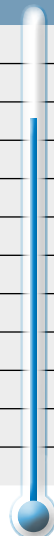

WEIGHT

1 ounce =	28.3495 g
1 pound =	0.45359 kg
1 hundredweight =	50.8023 kg

AREA

1 inch ² =	645.16 mm ²
1 foot ² =	0.0929 m ²
1 yard ² =	0.8361 m ²
1 acre =	4046.86 m ²
1 mile ² =	2.59 km ²

VOLUME

1 pint (UK) =	0.5683 l
1 pint (USA) =	0.4732 l
1 gallon (UK) =	4.5461 l
1 gallon (USA) =	3.7854 l

LENGTH

1 inch =	25.4 mm
1 foot =	0.3048 m
1 yard =	0.9144 m
1 furlong =	201.17 m
1 mile =	1.6093 km

PRESSURE

1 bar =	0.1 MPa
1 Pascal =	1 N / m ²
1 kgf / cm ² =	0.09807 MPa
1 psi =	6894.76 Pa

SI PREFIXES

NAME	SYMBOL	FACTOR
giga	G	10 ⁹
mega	M	10 ⁶
kilo	k	10 ³
hecto	h	10 ²
deca	da	10 ¹
deci	d	10 ⁻¹
centi	c	10 ⁻²
milli	m	10 ⁻³
micro	μ	10 ⁻⁶
nano	n	10 ⁻⁹

Bedding and sealing fittings and hardware

GENERAL DESCRIPTION

All kinds of deck fittings and hardware need to be securely fixed and totally watertight. Some of these fittings can be subject to very high forces, such as tensile, torsion and shear stresses. Poorly sealed joints can suffer serious damage such as metal corrosion, osmosis and water leaks which can cause damage to interior furnishings and fittings.

Bedding and sealing of fittings subject to high mechanical stresses

Deck fittings such as chain plates, winches and guide rollers must absorb very high dynamic stresses.

For this purpose a high-performance product, such as Sikaflex®-292i, should be used in conjunction with additional mechanical fixings.

Bedding and sealing of fittings subject to minimal mechanical stresses

Deck fittings, such as ventilators and cover strips, need to be waterproofed, but are not subject to high tensile or torsion stresses.





These fittings can be effectively bedded and sealed with Sikaflex®-295.





BEDDING AND SEALING FITTINGS AND HARDWARE

SUBSTRATE PREPARATION





TIMBER DECKS

	Abrade the contact area on the deck with a sanding pad (80 / 100 grit)
	Remove the dust with a vacuum cleaner
 SMM	Apply a thin, continuous coat of Sika® MultiPrimer Marine using a clean brush or a roller felt applicator.
	Drying times: Sika® MultiPrimer Marine 30 minutes (min) to 24 hours (max)

PAINTED DECKS





 SA 100	Pre-treat the substrate with Sika® Aktivator-100, using a clean, lint-free rag or a paper towel. Change the rag frequently!
	Flash-off: 10 minutes (min) to 2 hours (max)

BRONZE, BRASS OR STAINLESS STEEL FITTINGS





	Slightly abrade the contact area with a very fine sanding paper or abrasive pad
 SA 100	Pre-treat the substrate with Sika® Aktivator-100, using a clean, lint-free rag or a paper towel. Change the rag frequently!
	Flash-off: 10 minutes (min) to 2 hours (max)
 SMM	Apply a thin, continuous coat of Sika® MultiPrimer Marine, using a clean brush or a felt applicator
	Drying time: 30 minutes (min) to 24 hours (max)

For coloured metals please use only Sikaflex®-295 UV or Sikaflex®-591.

ALUMINUM FITTINGS

	Lightly abrade the contact area with a very fine sanding paper
 SA 100	Pre-treat the substrate with Sika® Aktivator-100, using a clean, lint-free rag or a paper towel. Change the rag frequently!
	Flash-off: 10 minutes (min) to 2 hours (max)
 SMM	Apply a thin, continuous coat of Sika® MultiPrimer Marine, using a clean brush or a felt applicator
	Drying time: 30 minutes (min) to 24 hours (max)

APPLICATION OF Sikaflex®-291i, -292i OR -295 UV ADHESIVES

	Mask the surrounding area before priming and sealing
	These adhesives should be applied to the deck and to the screw fixing holes in a bead of the required thickness. The fitting should then be pressed into position
	The fixing screws should be tightened slightly to leave about 1 mm of adhesive under the fitting
	Use a plastic spatula to remove excess sealant squeezed out around the edges and remove the masking tape
	After 24 hours tighten the screws

IMPORTANT:
For the preparation of other substrates, please refer to the Sika Pre-Treatment Charts for Marine Applications.



A selection of cleats that can be sealed or bonded using Sika adhesives



Applying Sikaflex®-292i



A port-hatch, both bonded and sealed using Sikaflex®

Bonding of rub rails and fenders

GENERAL DESCRIPTION

Rub rails and fenders are designed to protect the hull of a vessel against damage. These act as a bumper to absorb impacts and scrapes, and the more elastic these are, the more effectively they perform this function.

The elastic behaviour varies according to the type of material used, so the shockabsorbing performance of the rub rail can be significantly improved by the use of an elastic adhesive joint. This provides maximum protection to the hull.

Rub rails of timber, PVC or polyurethane can be securely bonded to marine hulls using Sikaflex®-292i. The resulting elastic joint helps to absorb most of the shear and tensile stresses to which they are subjected when a vessel is docking or casting off.

If rub rails are secured with screws, a similar effect can be obtained by back-filling the rail profile with Sikaflex®-291i; a highly elastic polyurethane sealant. As well as absorbing torsional stresses, this technology also seals the screw holes and prevents water or dirt from getting behind the rub rail.



IMPORTANT:







If the rub rail has a different chemical composition and is not fixed using a mechanical fixing method, please seek advice from your local Sika company.



BONDING RUB RAILS TO THE HULL

SUBSTRATE PREPARATION

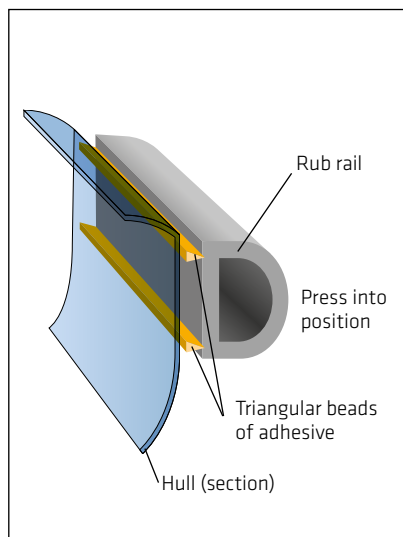

GRP HULLS

 208	Heavily soiled surfaces should first be cleaned off with a pure solvent, like Sika® Remover-208, to remove the worst of the soiling
	Lightly abrade the contact area with a very fine sanding pad
	Remove the dust with a vacuum cleaner
 SA 100	Pre-treat the substrate with Sika® Aktivator-100, using a clean, lint-free rag or a paper towel. Change the rag frequently!
	Flash-off: 10 minutes (min) to 2 hours (max)
 SMM	Apply a thin, continuous coat of Sika® MultiPrimer Marine, using a clean brush or a felt applicator
	Drying time: 30 minutes (min) to 24 hours (max)







Assembly of a rub rail







FINISHED PAINTED HULLS OF ALUMINUM OR STEEL, COATED WITH A TWO-PART LACQUER

 SA 100	Pre-treat the substrate with Sika® Aktivator-100, using a clean, lint-free rag or a paper towel. Change the rag frequently!
	Flash-off: 10 minutes (min) to 2 hours (max)









TIMBER RUB RAILS

	Abrade the contact area of the hull with a sanding pad (80 / 100 grit)
	Remove the dust with a vacuum cleaner
 SMM	Apply a thin, continuous coat of Sika® MultiPrimer Marine using a clean brush or a felt applicator.
	Drying times: Sika® MultiPrimer Marine 30 minutes (min) to 24 hours (max)

MOULDED PVC OR POLYURETHANE RUB RAILS

	The bond face of the rub rails must be free from mould release agents or other chemical contaminants. All traces of such substances must be removed before proceeding with Sika® Remover-208
	Abrade the bond face of the rub rail with coarse sand paper (60 / 80 grit) to key the surface
 SA 205	Pre-treat the substrate with Sika® Aktivator-205 using a lint-free rag or paper towel. Change rag frequently.
	Flash-off min. 10 min to max 2h.
 SMM	Apply a thin continuous coat of Sika® MultiPrimer Marine using a clean brush or felt applicator
	Drying time: 30 minutes (min) to 24 hours (max)

APPLICATION OF Sikaflex®-292i OR Sikaflex®-291i

	Apply a masking tape on the substrate
 292i 291i	Apply Sikaflex®-292i (or Sikaflex® 591 if rub rails are to be held using additional mechanical fixings) to the bond area using an appropriate triangular bead
	Assemble the components within 20 minutes of applying the adhesive
	Press the rub rail into place, either directly onto the face of the hull
	Use clamps, etc., to hold the rub rail in position while the adhesive sets. If the rub rail is to be secured with mechanical fixings, any holes should also be filled with adhesive
	Remove excessive adhesive and the masking tape
 208	Uncured Sika adhesives or sealants can be removed with Sika® Remover-208
	Clamps and other fastening aids can be removed after 24 hours. Full service strength is attained after approximately 7 days

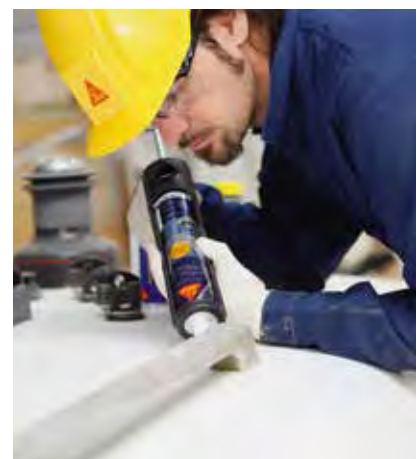

Sealing the edge of a chrome hand-rail

Bonding decorative panels and work surfaces

GENERAL DESCRIPTION



The interiors of many boats are based on a variety of traditional and modern materials including mirrored glass. These panels can be used functionally as working surfaces (galley worktops, etc.) or cosmetically. Either way, elastic bonding provides an easy, durable method of fixing without visible and unsightly mechanical fixings.

As the variety of materials used for panels, surfaces and supporting substrates is so vast, please consult the local Technical Service of Sika Industry or proceed to preliminary trials.









BONDING DECORATIVE PANELS AND TABLES

SURFACE PREPARATION

	Lightly abrade the bonding area with a very fine abrasive pad
 SMM	Apply a thin continuous coat of Sika® MultiPrimer Marine using a clean brush or felt applicator
	Sika® MultiPrimer Marine 30 minutes (min) to 24 hours (max)





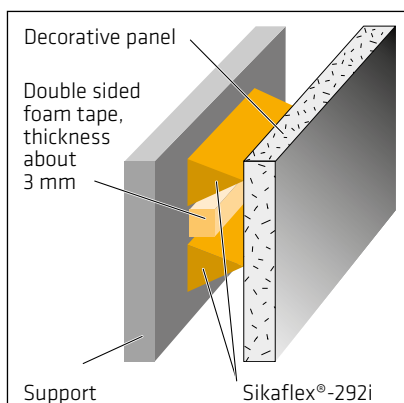

APPLICATION OF Sikaflex® ADHESIVE TO VERTICAL PANELS

	Prepare the substrate according to the Pre-Treatment Chart for Marine Application
	Place spacers in position (thickness 2 mm, approximately 50 Shore A hardness). These can be pressed into the adhesive once applied
	Apply appropriate beads of Sikaflex®-292i in an 8 mm x 10 mm triangular profile
	Assemble the components within 20 minutes of applying the adhesive
	Apply pressure with fastening aids to compress the adhesive to the height of the spacers
	Wait at least 24 hours before walking on the bonded plates
 208	Uncured Sika adhesives or sealants can be removed with Sika® Remover-208



Bonding a decorative panel vertically

APPLICATION OF Sikaflex® ADHESIVE TO HORIZONTAL PANELS

 298	Horizontal surfaces: Sikaflex®-298. Inclined surfaces: Sikaflex®-591
	Slightly abrade the surface with an abrasive pad very fine
 SA 205	Pre-treat the surface with Sika® Aktivator-205 with a lint-free rag or paper towel. Change the rag frequently!
	Flash-off time min. 10 min to max. 2 h
	Apply adhesive to the previously prepared surface and spread over the area to be covered, using a spreader with 4 mm triangular notches. The bed thickness may vary depending on the thickness of any gaps that needs to be filled (normally 1-2 mm)
	If vapour-tight substrates are used, spray a fine mist of water (1 g / m ²) onto the Sikaflex®-298 surface for faster curing
	The deck panel must be positioned accurately within the tack free time of the adhesive and pressed firmly into place to avoid air-entrapment
	Clamps, weights or screws (removable once the adhesive has set) can be used to secure the panel while the adhesive sets. After about 24 hours the panels can carry their full service load and the temporary fastenings can be removed

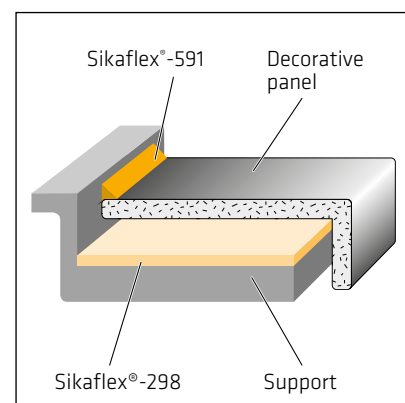

Bonding a decorative panel vertically



A galley work surface fitted using Sikaflex®-292i



IMPORTANT:
Always refer to the current Sika Product Datasheets and Safety Datasheets obtainable through your local Sika company



Application of Sikaflex®-591

Bonding lightweight internal partitions

GENERAL DESCRIPTION

These lightweight panels are usually constructed of wood sandwiches with internal polyurethane foam or honeycomb core. They are particularly suited as partitions for cabins and technical rooms as they are of lighter weight than wood filled panels and have good soundproofing properties.

Due to the low density core, lightweight panels cannot be mechanically fixed to the hull structures in the same way as traditional plywood panels.

However, bonding with Sikaflex®-292i is an ideal replacement fixing method that also possesses the flexibility to respond to the movements and stresses of the assembly.

The uniform stress distribution prevents damages which may be result of stress concentration (example screw).

This process is also endorsed by the manufacturers of the lightweight panels.

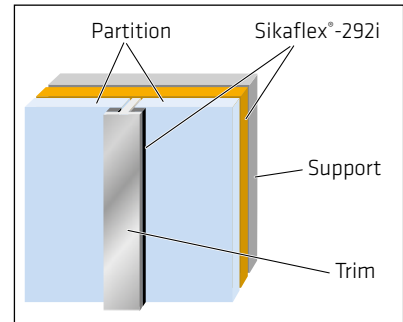

Sikaflex®-292i bead application for bonding to the support









BONDING LIGHTWEIGHT INTERNAL PARTITIONS

SUBSTRATE PREPARATION

Please refer to the Sika Pre-Treatment Chart for Marine Applications.

APPLICATION OF Sikaflex®-292i ADHESIVE

	Dry fit the panels to ensure an accurate fit and correct dimensioning. Prepare the surface accordingly
	Place the spacers in position (thickness typically 3 mm, approximately 50 Shore A hardness)
	Apply Sikaflex®-292i to the appropriate bond face using an appropriate bead
	Assemble the components within 20 minutes of applying the adhesive
 208	Uncured Sika adhesives or sealants may be removed with Sika® Remover-208
	Panels can be held in place during cure by clamps or support brackets
	Clamps and other fastening aids can be removed after 24 hours



Sikaflex®-292i applied to a lightweight panel prior to fitting



Lightweight panels being fitted to an open hull



High-quality lightweight panels finished in traditional high-gloss wood veneer and bonded using Sikaflex®-292i

Sika solutions for structural bonding

MATERIALS AND TECHNOLOGIES

The main property of elastic bonding adhesives is that they are capable to support high mechanical stresses.

This single detail gives rise to concerns regarding the finished vessel in service, where, despite the improved assembly benefits, there can still be localised stress issues and a greater possibility of joint fracture due to impact or crushing forces.

Following extensive research, Sika has found that by introducing a degree of flexibility, these problems are greatly improved.

The Sikaflex® elastic adhesives for structural bonding are:

- Sikaflex®-292i
- Sikaflex®-296
- Sikaflex®-295 UV

Sikaflex®-292i is used to bond flybridges and keels as each of these can be subject to far greater local forces than other main components. The greater flexibility in these cases means that there will be greater 'give' in the first instance. The members would be more likely to be pulled off the vessel whole, without ripping pieces from the hull or superstructure. This also means that there is every chance that the components can be refitted without needing to be replaced.

Sikaflex®-295 UV and -296 are each used for glazing, as windows are increasingly used as structural members. Sikaflex®-295 UV is used for organic glazing and backfilling and Sikaflex®-296 is used for mineral glazing. In both cases the greater flexibility is to prevent forces being transmitted to the glazing that would otherwise damage it.

The following examples show the capability of the Sikaflex® Marine adhesives. However the custom tailored characteristics gives naval engineers and constructors the possibility of economic and sustainable new realisations. Sika will be happy to support you in the development and testing of new applications.



		MECHANICAL FIXING	LAMINATING TAPING	ELASTIC BONDING
MANUFACTURING	Time consumption	●	●	○
	Material cost	●	●	●
	Process complexity	● / ●	●	●
	Health / safety / environment	● / ○	●	●
	Tolerance gapping	●	●	●
	Assembling different (lightweight) materials	●	●	●
FINAL PERFORMANCE	Durability / fatigue resistance	○	●	●
	Durability / corrosion resistance	●	●	●
	Weight reduction	●	●	●
	Comfort (acoustics)	●	●	●

● Very good ● Good ○ Neutral ● Poor ● Very poor



Direct glazing

DESCRIPTION

Traditional glazing methods have evolved as they had due to the limitations in the performance of the glass. A sturdy window frame was required to hold the glass in place and to protect it from forces that would shatter it. Also, the size of a window was limited for similar reasons and a broken window in heavy weather could compromise the safety of the vessel.

In addition marine regulations define the areas on the ship where bonding of windows is allowed and where additional mechanical fixations are necessary. It is therefore of interest to contact a Classification Society in case of vessels which are submitted to IMO and SOLAS or other national rules.

Modern glazing can be realised with mineral and organic glasses. The manufacturing techniques allow windows of

superlative performance to be produced in almost any shape, size and curvature to give designers the possibility of modern realisation of ships.

The traditional role of glazing as protection against the elements whilst allowing light and vision to pass through, has been extended to include the extra benefit of structural member.

Direct glazing, using peripherally applied structural adhesive systems, has become the primary method of installing windows due to the extensive list of benefits:

- Better protection against the elements than framed windows.
- Significantly improved design and styling capabilities for the marine architect by elimination of trim, frame and screws.
- Enlarged window area permits a more imaginative styling.
- Lower weight reduces running costs and improves speed.
- Fewer materials required reduce the cost of the build with lower component cost and quicker assembly times.
- Improved torsion stiffness of the boat.
- Reduction of the natural frequencies and vibrations, leading to an improved ride comfort.
- Improved aerodynamics reducing wind noise in operation.
- Better bridging of tolerances which has the advantages of quicker assembly and reduced adjustment costs.
- Greatly reduced production times leading to quicker delivery and lower labour costs.
- Fewer glass breakages both during construction and in operation.
- Easy repair at any place due to Sika's global presence.



DESIGN DIRECTIVES

Direct glazing represents a straightforward process whereby the glass is bonded directly to the body of the vessel. This must comply with all industry standards as laid down by the governing bodies, such as the classification societies, in each respective country. Specific details are described as appropriate for mineral and organic glazing later in this manual, but the general criteria are described following.

UV PROTECTION

The bond line material must be protected from direct UV radiation as this causes deterioration of the chemical composition leading to failure. This is normally carried out by including a light impermeable mask as part of the design of the window. This can appear in the form of:

- Ceramic coating (peripheral) for mineral glass
- UV impervious paint or ink for organic glass
- External trim

The black silk screened ceramic border around the edge of the window is often feathered towards the centre of the window using various dot densities, resulting in an attractive shading effect. Adhesives can also be protected using external trim that is large enough to keep out the ultraviolet light and is also attractively designed such to enhance the appearance of the finish.

See page 39 for organic glass and page 42 for mineral glass for dimensioning the adhesive layer.

FITTING DIMENSIONS

Not only does the window have to fit correctly into the allotted aperture during assembly, but it must also take into account the changes that occur to the superstructure and the window under operating conditions.

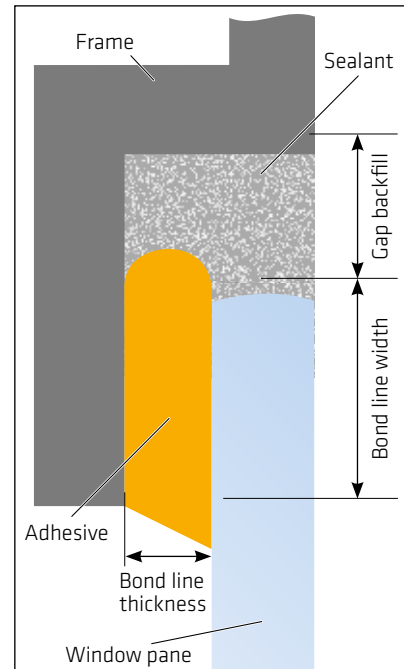

Bonding a decorative panel vertically

BOND LINE WIDTH

The overlapping area between the frame and the glazing, known as the bond line width, should be large enough to allow sufficient adhesive to bear the weight of the glazing, as well as the suction load and head pressure to which the environment exposes it. A dimensioning guide is provided adjacent to the different procedures for mineral and organic windows.

BOND LINE THICKNESS

After it has set, the adhesive remains flexible. However, if too thinly applied, the adhesive may shear due to the changes in dimension caused by differences in thermal coefficient of expansion between the glazing and the superstructure and also the natural flexing between the glazing and the window frame in the varying sea conditions. Sika's dimensioning guide provided adjacent to the appropriate procedures determines the depth of spacers required to be placed within the adhesive to keep the distance equal to or greater than the minimum depth required to ensure the reliability and longevity of the adhesive and the bond.

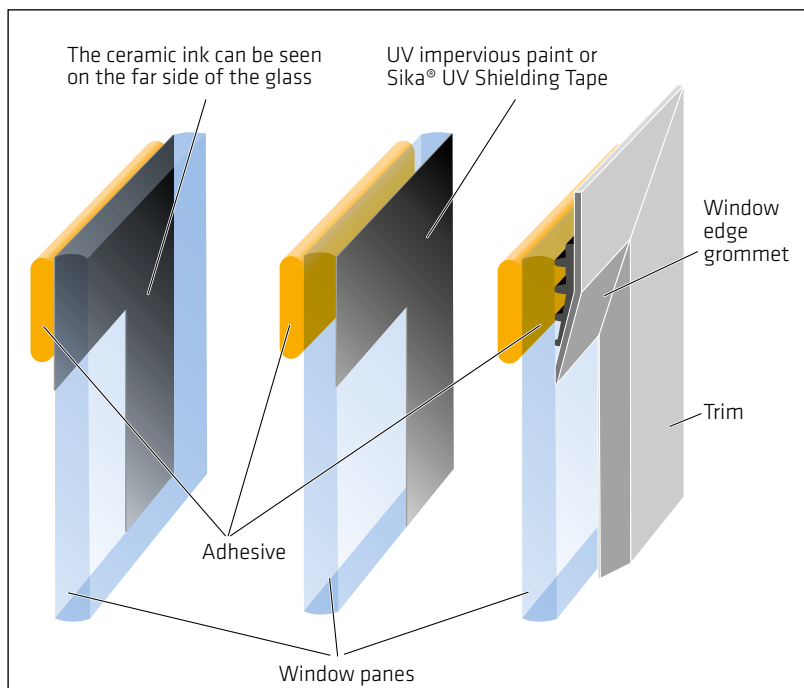

Bonding a decorative panel vertically

GAP BACKFILLING

Around the edge of the glazing, there should be a gap sufficient to prevent contact between the glazing and the window frame for all temperatures and under all mechanical strains. A dimensioning guide is provided adjacent to the appropriate procedures.

SURFACE PREPARATION

The adhesion properties between the glazing and the window mounting material must be verified by Sika's Technical Department to ensure that the correct materials, solutions and methods are used and followed. Procedure for organic and for mineral glass are described on the following pages. Improperly prepared surfaces could result in failure of the bond and may put the safety of the vessel in jeopardy.

The high quality of Sika products is guaranteed and whereas Sika cannot vouch for the quality or compatibility of other manufacturer's products, only Sika primers, cleaners and adhesion promoters should be used with Sika adhesives and sealants.

PRIMERS AND CLEANERS

Flash off times for cleaners and primers must be strictly observed.

PRODUCT SELECTION FOR BOTH MINERAL AND ORGANIC WINDOWS

Selection of the correct surface preparation system is of utmost importance; as is the selection of the correct adhesive. These both depend on the type of window to be installed. The following table shows which adhesive should be used:

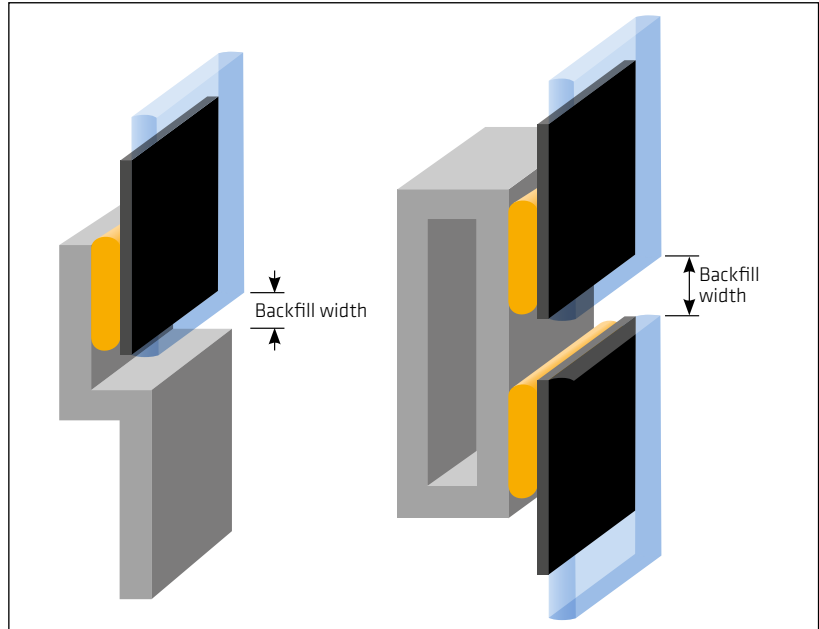

The definition of backfill width

Bonding System	Cleaner	Primer	Adhesive	Sealant
Laminated	Sika® Aktivator-100	Sika® Primer-206 G+P	Sikaflex®-296	Sikaflex®-295 UV
Mineral Glass				Sikaflex®-296
	Sika® Aktivator-100	Sika® Primer-206 G+P	Sikasil® SG-20	Sikasil® SG-20
				Sikasil® WS-605 S
Insulating	Sika® Aktivator-100	Sika® Primer-206 G+P	Sikaflex®-296	Sikaflex®-295 UV
Mineral Glass				Sikaflex®-296
	Sika® Aktivator-100	Sika® Primer-206 G+P	Sikasil® SG-20	Sikasil® SG-20
				Sikasil® WS-605 S

Sika® Primer-206 G+P can be eliminated if proper UV-protection of the bond line is ensured.

Bonding System	Grinding	Primer	Adhesive	Sealant
PC/PMM	Abrasive pad very fine	Sika® Primer-209 D	Sikaflex®-295 UV	Sikaflex®-295 UV
PC/PMM	Abrasive pad very fine	Sika® Primer-209 D	Sikasil® SG-20	Sikasil® WS-605 S



Sealing and bonding organic windows

APPLICATION DESCRIPTION

Most of the organic glazing materials used in boat building are clear acrylic sheet (PMMA).

Plastic glazing products have a high coefficient of thermal expansion. In general, incorrectly installed plastic glazing panels are prone to environmental stress cracking (ESC). This can be aggravated by the use of the wrong adhesives or wrong dimensioned adhesive / sealant.

Plastic glazing products have a higher coefficient of thermal expansion than conventional glass.

Therefore, when designing glazing installations, an expansion gap of at least 8 mm all round the periphery must be incorporated between the window rebate and the plastic glazing panel to accommodate thermal movement. In case of additional mechanical fixations any clearance holes for fixing screws must be drilled oversize; slightly larger than the diameter of the screw shank. See also plastic manufacturer recommendations.

To minimise the risk of environmental stress cracking, flat sheets of plastic glazing material should be installed completely flat; they should not be forced to take up a curvature by the use of mechanical fastenings.

When the design calls for curved glazing panels, these should be prefabricated to order and properly tempered by a specialist supplier to ensure installation with no remaining stresses.

As many varieties of organic window exist, it is recommended to ensure that the specific grade selected is suitable for use with Sikaflex®-295 UV. Please note that the extruded type of organic glazing (XT) exhibits a higher tendency to environmental stress cracking than the cast type (GS).

Please contact your local Sika company for technical advice.



PROCEDURE FOR BONDING AND SEALING WITH Sikaflex®-295 UV ORGANIC WINDOWS

BONDLINE CONFIGURATION

Organic windows have a high thermal movement which creates stress in the bond line. Additionally dynamic stress due to the boat movement and the wind load have to be taken in consideration.

The following graphs are a result of theoretical and practical experience, considering all parameters of a boat under the conditions to which a window is subjected.

Basis of calculation are substrates MMA/GFK, wind load 2 kN/m², ΔT = 30° C

ADHESIVE WIDTH (BITE)

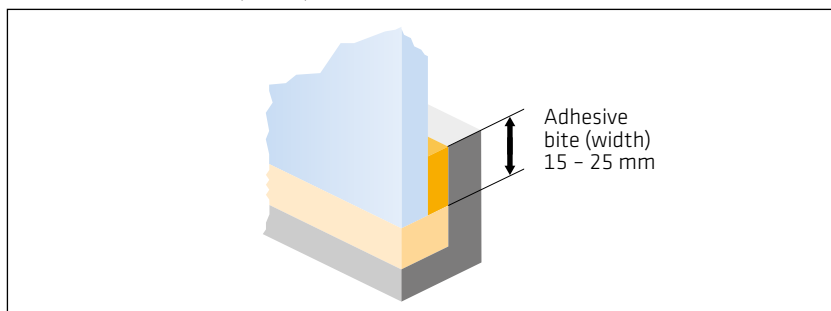

JOINT THICKNESS

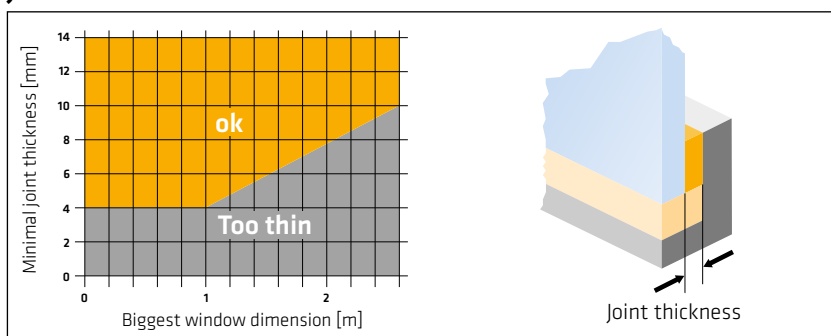

JOINT WIDTH

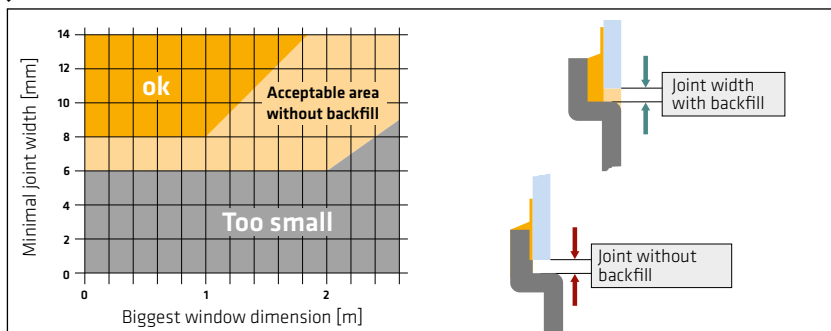

Note: For important projects consult Corporate Technical Service Sika Industry

SUBSTRATE PREPARATION

GRP FRAME

	Lightly abrade the gel coat of the contact area with a very fine sanding pad
	Remove the dust with a vacuum cleaner
	Mask off any areas that need it
 SA 205	Pre-treat the substrate with Sika® Aktivator-205, using a clean, lint-free rag or paper towel. Change the rag frequently!
	Flash-off: 10 minutes (min) to 2 hours (max)
 SMM	Apply a thin, continuous coat of Sika® MultiPrimer Marine, using a clean brush or felt applicator
	Drying time: 30 minutes (min) to 24 hours (max)

ALUMINUM FRAME

	Mask off any areas that need it
	Lightly abrade the contact area with a fine sand pad
	Remove the dust with a vacuum cleaner
 SA 205	Pre-treat with Sika® Aktivator-205, using a clean, lint-free rag or paper towel. Change the rag frequently!
	Flash-off: 10 minutes (min) to 2 hours (max)
 SMM	Apply a thin, continuous coat of Sika® MultiPrimer Marine, using a clean brush or felt applicator
	Drying time: 30 minutes (min) to 24 hours (max)

ALUMINUM OR TIMBER FRAME COATED WITH TWO-PART LACQUER

	Mask off any areas that need it
 SA 100	Pre-treat the substrate with Sika® Aktivator-100, using a clean, lint-free rag or paper towel. Change the rag frequently!
	Flash-off: 10 minutes (min) to 2 hours (max)



IMPORTANT:
For the preparation of other substrates, please refer to the Pre-Treatment Chart for Sika Marine Applications or contact the local Technical Service Sika Industry

PMMA / PC GLAZING PANELS

	If required, apply an acryl paint or a profile opaque to cover the bond line in accordance with the Sika recommendations.
	Abrade the bond area with abrasive paper or very fine abrasive pad. Abrade the bonding periphery with 80 grit sand-paper if the organic glazing panel has a scratch proof coating (example Margard)
	Remove the dust with a vacuum cleaner
	Mask off any areas that need it
	Apply a continuous coat of Sika® Primer-209 D, using a clean brush or felt applicator
	Drying time: 30 minutes (min) to 24 hours (max)

BOND LINE PROTECTION

As with conventional glass, plastic glazing panels generally do not protect the adhesive face from damage by UV radiation. Therefore, the bond line must be protected from direct sunlight using one of the methods recommended.

- External cover strip of appropriate dimensions
- Internal sieve printing acrylic paint (contact Technical Service Sika Industry for appropriated types)

The use of black Primer Sika® Primer-209 D as a sole UV-protection is only permitted in case of a low UV-transmission of the organic glass (UV-transmission < 0,5%)

APPLICATION OF Sikaflex®-295 UV ADHESIVE

	Place spacers in position. Depending on the size of the glazing panel, the thickness of the spacer should be chosen accordingly (see page 16). Shore A hardness of the spacer approximately 30 or less
	Avoid interruption of the bead by the spacers
	Apply Sikaflex®-295 UV to the frame rebate or glazing panel using a triangular nozzle with a bead width of at least 10 mm
	Assemble all components within 20 minutes of applying the adhesive
	To prevent slip down of vertical glazing panels, distance blocks (wood or plastic) must be placed in the lower rebate during installation. After curing, these must be removed. The backfill gap must be at least 8 mm (see page 16)
	Fastening aids can be removed after 24 hours. After this time, the expansion gap between glazing panel and the backfill gap should be filled and completely sealed with Sikaflex®-295 UV. This sealant joint can be tooled to a smooth finish using Sika® Tooling Agent N. This must be carried out before skinning of the sealant
	After tooling remove any masking tape before the adhesive skins over
	Uncured Sika adhesives or sealants may be removed with Sika® Remover-208

WINDOW EDGE SEALING/ BACKFILLING

Commonly, the edge of the window will be cosmetically finished with Sikaflex®-295 UV. The preparation of the surfaces must be identical to that used for bonding. Edge sealing ensures both the prevention of standing water on or near the bond and helps cosmetically finish the window. Fill up the joint completely, ensuring there is no space between the adhesive bead and the joint. The diagram on page 9 illustrates the required dimensioning of the back-fill gap for plastic window panels using Sikaflex®-295 UV.



IMPORTANT:
Always refer to the current Sika Product Datasheet and Safety Datasheet obtainable through your local Sika company

SIKA RULE

$$O = 2 \times D$$

Example:

If D = 8 mm, the overlap should be at least 16 mm

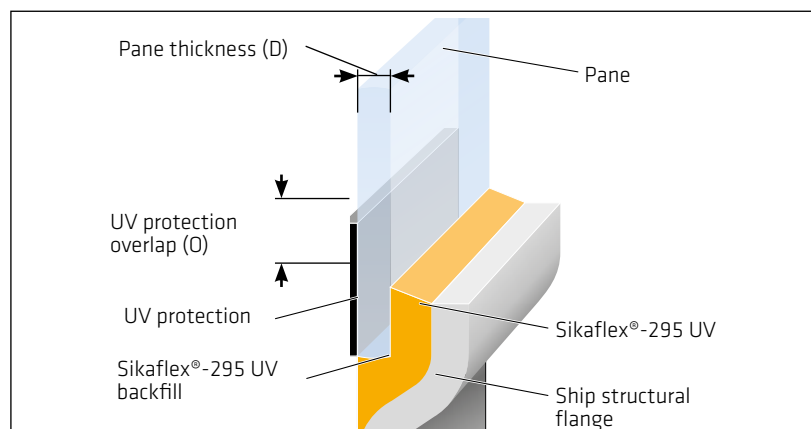

Bonding a decorative panel vertically

Sealing and bonding mineral glazing

APPLICATION DESCRIPTION

The direct mineral glazing into frames or directly into the hull or deck, requires a full understanding of all the important principles involved.

It is essential that the glass meets all the demands and standards required for the intended application, such as IMO resolutions or other regulations as laid down by the classification societies.

In case of self cleaning glass we ask you to consult the Corporate Technical Service Sika Industry.

The adhesive bond line must be protected against UV radiation.

This may be achieved using several materials and methods:

- Using a black, ceramic coated border with a light transmission of less than 0.01%.



IMPORTANT:

Local and international rules for maritime constructions and appropriate legislation must always be observed.



BONDING AND SEALING MINERAL GLASS WITH Sikaflex®-296

ADHESIVE AND SEALANT DIMENSIONING

The dimensioning of the adhesive and the joint geometry must be carried out in accordance with Sika's basic rules of calculation. If deck movement is negligible the following dimensions are recommended.

IMPORTANT:
At all times recommendations from classification societies must be respected

Basis of calculation substrate aluminum-glass, wind load 2,4 kN/m², ΔT = 40° C

DETERMINATION OF THE ADHESIVE WIDTH (BITE)

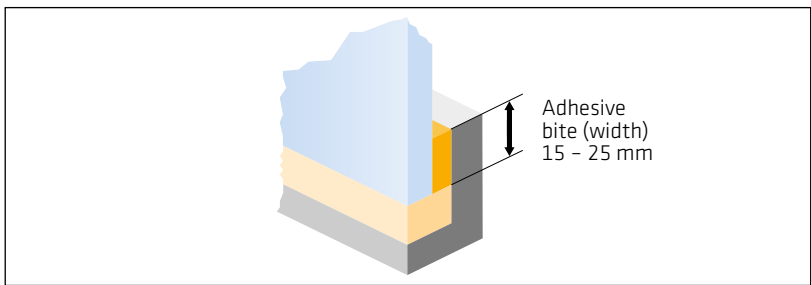

ADHESIVE THICKNESS

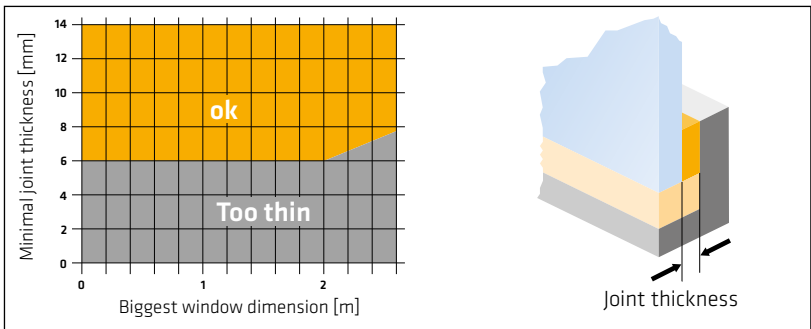

JOINT WIDTH

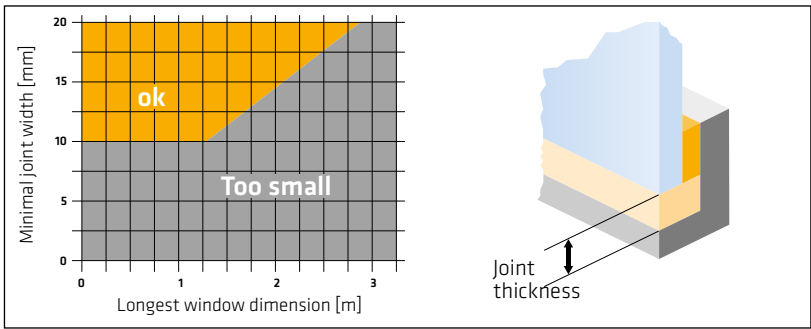

Note: For insulating glass or important projects consult Corporate Technical Service

SUBSTRATE PREPARATION

GRP FRAME

- Lightly abrade the gel coat of the contact area with a very fine sanding pad
- Remove the dust with a vacuum cleaner
- Mask off any areas that need it
- Pre-treat the substrate with Sika® Aktivator-205, using a clean, lint-free rag or paper towel. Change the rag frequently!
SA 205
- Flash-off: 10 minutes (min) to 2 hours (max)
- Apply a thin, continuous coat of Sika® MultiPrimer Marine, using a clean brush or felt applicator
SMM
- Drying time: 30 minutes (min) to 24 hours (max)

For the preparation of other types of frames, please refer for the Pre-Treatment Chart for marine application.





GLASS WITH EXTERNAL UV PROTECTION OR WITH BLACK CERAMIC BORDER (TRANSMISSION < 0.01%)





- Pre-treat the substrate with Sika® Aktivator-100, using a clean, lint-free rag or paper towel. Change the rag frequently!
SA 100
- Flash-off: 10 minutes (min) to 2 hours (max)



GLASS WITH BLACK CERAMIC GLASS BORDER (TRANSMISSION > 0.01% VISIBLE LIGHT)

- Pre-treat the substrate with Sika® Aktivator-100, using a clean, lint-free rag or paper towel. Change the rag frequently!
SA 100
- Flash-off: 10 minutes (min) to 2 hours (max)
- Apply a thin, continuous coat of Sika® Primer-206 G+P, using a clean brush or felt applicator
206 G+P
- Drying time: 30 minutes (min) to 24 hours (max)

APPLICATION OF Sikaflex®-296 ADHESIVE

	Place spacers in position. Depending on the size of the glazing panel, the thickness of the spacer should be chosen accordingly. Shore A hardness of the spacer approximately 40 or less
	Avoid interruption of the bead by the spacers
 296	Apply Sikaflex®-296 to the frame rebate or glazing panel using a triangular nozzle with a bead width of at least 10 mm
	Assemble all components within 20 minutes of applying the adhesive

	To prevent slip down of vertical glazing panels, distance blocks (wood or plastic) must be placed in the lower rebate during installation. After curing, these must be removed. The rebate gap must be at least 10 mm (see page 16)
	Clamps and other fastening aids can be removed after 24 hours.
 296	After this time, the expansion gap between glazing panel and the rebate should be filled and sealed with Sikaflex®-296. This sealant joint can be tooled to a smooth finish using Sika® Tooling Agent N. This must be carried out before skinning of the sealant
 Tooling	

	After tooling remove any masking tape before the adhesive skins over
 208	Uncured Sika adhesives or sealants can be removed with Sika® Remover-208



Pre-treatment of the ceramic ink area with Sika® Aktivator-100



Adhesive is applied to the window frame



The window is fitted

Flybridge bonding

APPLICATION DESCRIPTION

Many modern motor yachts have flybridges. Conventional fixing methods such as mechanical fixings or rigid adhesives have concentrations of peak stresses which lead to breaching of the substrate allowing access to moisture.

Bonding of flybridges using flexible adhesive systems evens the distribution of stresses and optimises resistance to impact and fatigue effects.

In service, flybridges are subjected to substantial stress on the joints at high speeds. The main reason that makes Sikaflex®-292i perfect for







this application is the high modulus characteristic that ensure the integrity of the joint under stress.

A perfect cosmetic finish is obtained with the weather resistance Sikaflex®-295 UV in white colour.



FLYBRIDGE BONDING PROCEDURE





PREPARING THE SUBSTRATE GRP

 208	Heavily soiled surfaces should first be cleaned off with a pure solvent, like Sika® Remover-208, to remove the worst of the soiling
	Lightly abrade the contact area with a very fine sanding pad
	Remove the dust with a vacuum cleaner
 SA 205	Pre-treat the substrate with Sika® Aktivator-205, using a clean, lint-free rag or a paper towel. Change the rag frequently!
	Flash-off: 10 minutes (min) to 2 hours (max)
 SMM	Apply a thin, continuous coat of Sika® MultiPrimer Marine, using a clean brush or a felt applicator
	Drying time: 30 minutes (min) to 24 hours (max)





Sealing with Sikaflex®-295 UV

APPLICATION OF Sikaflex®-292i ADHESIVE

	Place 3 mm deep elastic spacers, of about 50 Shore A hardness, into position
 292i	Apply Sikaflex®-292i in an appropriate profile around the entire periphery of the flybridge. An additional bead may be required for heavier loads
	Assemble the components within 20 minutes of applying adhesive
	Apply pressure with clamps or other fastening aids to compress the adhesive to the height of the spacers



 208	Uncured Sika adhesives or sealants should be removed with Sika® Remover-208
 295 UV	For open joints, cover Sikaflex®-292i with a layer of Sikaflex®-295 UV
	Clamps and other fastening aids can be removed after 12 hours. Full service strength is attained after about 7 days

IMPORTANT:
Always refer to the current Sika Product Datasheet and Safety Datasheet obtainable through your local Sika company

Deck and keel to hull bonding

APPLICATION DESCRIPTION

Arguably the most crucial joint on the vessel is that between the deck and the hull where Sika's resilient, 1-component polyurethane adhesives have many benefits to the designer and boat builder alike.

The naval architect can be confident that a deck and a hull that have been built separately of differing materials can be brought together to form a single unit that is both strong and durable. The tolerances in alignment between the two parts need not be quite as close, because minor discrepancies can be taken up by the gap filling property of the adhesives.

The strength of the adhesives makes mechanical fixings redundant and the resilience absorbs much of the stresses and strains from temperature changes, impact shocks and torsion forces.

All of these factors reduce the design and source costs of the build and remove many design obstacles.

To the boat builder, the assembly techniques are simplified and streamlined.

Applying an adhesive around the joint between deck and hull is far quicker, simpler and easier than laborious GRP laminated joints.

And providing the Sika guidelines are followed ensures a reliable watertight joint, as is not the case with taping methods.

With no mechanical fixings, there is no need to drill holes in the joint area, no need for gaskets, no need to spend the time aligning the holes and no need to insert and tighten the fixings.

For information regarding bondline dimensions, please contact Sika's Technical Service department, who can also provide appropriate values for FEM calculations.







Also, the critical joint between keel and hull is subjected to very high stresses when a boat is under sail and needs to be very strong if it runs aground. So it must be designed and built with great care in order to withstand these stresses.

This particular joint is prone to leaks, which identify themselves by rust streaking and staining on the keel when the boat is out of the water.









DECK TO HULL BONDING PROCEDURES WITH Sikaflex®-292i

PREPARING THE SUBSTRATE FOR ALUMINIUM

 208	Heavily soiled surfaces should first be cleaned off with a pure solvent, like Sika® Remover-208, to remove the worst of the soiling
	Lightly abrade the contact area with a very fine sanding pad
	Remove the dust with a vacuum cleaner
 SA 205	Pre-treat the substrate with Sika® Aktivator-205, using a clean, lint-free rag or a paper towel. Change the rag frequently!
	Flash-off: 10 minutes (min) to 2 hours (max)
 SMM	Apply a thin, continuous coat of Sika® MultiPrimer Marine, using a clean brush or a felt applicator
	Drying time: 30 minutes (min) to 24 hours (max)

PREPARING THE SUBSTRATE FOR GRP

 208	Heavily soiled surfaces should first be cleaned off with Sika® Remover-208, to remove the worst of the soiling
	Lightly abrade the contact area with a very fine sanding pad
	Remove the dust with a vacuum cleaner
 SA 205	Pre-treat the substrate with Sika® Aktivator-205, using a clean, lint-free rag or a paper towel. Change the rag frequently!
	Flash-off: 10 minutes (min) to 2 hours (max)
 SMM	Apply a thin, continuous coat of Sika® MultiPrimer Marine, using a clean brush or a felt applicator
	Drying time: 30 minutes (min) to 24 hours (max)

OTHER SUBSTRATE

Refer to the actual Sika Pre-Treatment Chart for Marine Applications.

APPLICATION OF Sikaflex®-292i

 **IMPORTANT:**
It is vital to check the accuracy of the fit before applying the adhesive so that the parts do not need to be separated again once they have been brought together

 Place spacers of at least 4 mm deep and about 50 shore A hardness, in position. Alternatively, these can be pressed into the adhesive once applied



292i Apply Sikaflex®-292i onto the entire periphery of the hull. A continuous zig-zag bead Sikaflex®-292i should be used; the amount applied will depend on the width of the bond face. The adhesive bead must be carried continuously around any cut-outs or clearance holes (e.g. for deck stanchions, pipes, chain plates) to maintain the integrity of the watertight joint

 Assemble the components within 20 minutes of applying the adhesive

 Apply pressure with clamps or other fastening aids to compress the adhesive to the height of the spacers

 Clamps and other fastening aids can be removed after 24 hours. Full service strength is attained after approximately 7 days

208 Uncured Sika® adhesives or sealants must be removed with Sika® Remover-208

 **IMPORTANT:**
Do not use Sika® Aktivator or any other cleaning agent or solvent for cleaning purposes



Hull and deck are brought together



A locating pin ensures perfect alignment

KEEL TO HULL BONDING

PREPARING THE SUBSTRATE ALUMINUM HULLS (PAINTED WITH ZC PAINT)



Heavily soiled surfaces should first be cleaned off with Sika® Remover-208, to remove the worst of the soiling



Pre-treat the substrate with Sika® Aktivator-100, using a clean, lint-free rag or a paper towel. Change the rag frequently!



Flash-off: 10 minutes (min) to 2 hours (max)

PREPARING THE SUBSTRATE FOR GRP



Heavily soiled surfaces should first be cleaned off with Sika® Remover-208, to remove the worst of the soiling



Lightly abrade the contact area with a very fine sanding pad



Remove the dust with a vacuum cleaner



Pre-treat the substrate with Sika® Aktivator-205, using a clean, lint-free rag or a paper towel. Change the rag frequently!



Flash-off: 10 minutes (min) to 2 hours (max)



Apply a thin, continuous coat of Sika® MultiPrimer Marine, using a clean brush or a felt applicator



Drying time: 30 minutes (min) to 24 hours (max)

STEEL HULLS AND KEELS, COATED WITH TWO-PART CORROSION PROTECTION PAINTS



IMPORTANT:
1-component paints are not suitable to be bonded on it. To control the quality of the paint we recommend cleaning a small part with paint thinner. If the paint resists to the solvent it is suitable and can be bonded as described in the following part. In case of the paint can be dissolved, it has to be removed and replaced by a two-component epoxy paint



Pre-treat the substrate with Sika® Aktivator-100, using a clean, lint-free rag or a paper towel. Change the rag frequently!



Flash-off: 10 minutes (min) to 2 hours (max)



A keel is carefully slid into position



The adhesive is applied



IMPORTANT:
With lead keels, the contact area must also be given a coating with a two-part epoxy-resin based protective paint

For the preparation of other substrates, please refer to the Pre-Treatment Chart for Sika Marine Applications.



The joint is tooled off and finished

APPLICATION OF Sikaflex®-292i ADHESIVE



Place elastic spacers of about 10 mm thick and 50 Shore A hardness into position



Apply Sikaflex®-292i in sufficient quantity. Each bead must form a continuous, closed ring, with no gaps. The same applies to the beads around the bolt holes



The keel must then be lifted into position, carefully observing the open time of Sikaflex®-292i. Then the keel bolts must be tightened as far as the spacer blocks. Any adhesive that is squeezed out of the joint can be tooled to a finish



Remove Sika adhesives or sealants with Sika® Remover-208



After three or four days, the keel bolts can be tightened to their full torque rating. The additional pressure exerted on the adhesive, gives the joint between keel and hull the required degree of torsional stiffness. When the adhesive has fully hardened, the sealed joint can be over-painted in the normal way with any good quality anti-fouling paint. The sealed joint absorbs the dynamic stresses generated in this area and forms a totally watertight bond between keel and hull

RECOMMENDATIONS FOR SIKA MARINE RANGE

PRECONDITION:

Surfaces have to be clean, dry and free of oil, grease, dust and loose particles. Depending on the nature of soiling, Sika® Remover-208, Sika® Cleaner P or another suitable cleaning solution may be used. For substrates that are prone to oxidation and/or have a weak surface layer it might be necessary to abrade the surface down to sound material. Verify compatibility with cleaning products.

Substrate	EN*	Sikaflex®-291i Sikaflex®-298			Sikaflex®-295 UV			Sikaflex®-292i Sikaflex®-296			Sikasil® WS-605 S Sikasil® SG-20 Sika® Firesil Marine N			Sikaflex®-591			
		Mechanical	Adhesion Promoter	Primer	Mechanical	Adhesion Promoter	Primer	Mechanical	Adhesion Promoter	Primer	Mechanical	Adhesion Promoter	Primer	Mechanical	Adhesion Promoter	Primer	
Aluminum (AlMg3, AlMgSi1)	1	AP-C	SA-100 SA-205	SMM	AP-C	SA-205	SMM	AP-C	SA-205	SMM	AP-C	SA-205	AP-C	SA-205	SA-100		
Aluminum (anodized)	2		SA-100 SA-205	SMM		SA-100 SA-205	SMM	AP-C	SA-100 SA-205	SMM		SA-205			SMM		
Steel (stainless)	3	AP-C	SA-100 SA-205	SMM	AP-C	SA-205	SMM	AP-C	SA-205	SMM	AP-C	SA-205			SA-205 SA-100		
Steel (hot dipped, galvanized)	4	AP-C	SA-205	SMM	AP-C	SA-205	SMM	AP-C	SA-205	SMM	AP-C	SA-205			SA-205 SA-100		
Non ferrous materials (copper, brass, bronze,...)	5				AP-C	SA-205	SMM				AP-C ⁸	SA-205 ⁸	SMM ⁸		AP-C	SA-205	SMM
Metal with shop primer	6		SA-100		AP-C ³	SA-100 SA-100	SMM SP-206 GP	AP-C ³	SA-100 SA-100	SMM SP-206 GP		SA-205			SA-205 SCP		
Metal with 2C Ac/PU-paint	6		SA-100			SA-100 SA-100	SP-206 GP		SA-100 SA-100	SP-206 GP		SA-205			SA-205 SCP		
FRP (unsaturated polyester) gelcoat side or SMC	7		SA-100	SP-209 D	AP-C	SA-205	SP-209 D SMM	AP-C	SA-205	SP-209 D SMM		SA-205 ⁷	SMM ⁷		AP-C	SA-205 SCP	
FRP (unsaturated polyester) lay-up side	7	GR-V	SP-290 DC SP-209 D		GR-V	SP-290 DC SP-209 D		GR-V	SA-205 SP-209 D	SP-290 DC SP-209 D		SA-205 ⁷			GR-V	SA-205 SMM	
ABS	8		SP-290 DC SP-209 D			SP-290 DC SP-209 D			SA-205 SP-290 DC SP-209 D			SA-205 ⁷			SA-205	SP-290 DC	
Hard PVC	8		SP-290 DC SP-209 D						SA-205 SP-290 DC SP-209 D			SA-205 ⁷			SA-100	SP-290 DC	
PMMA/PC (without anti scratch coating)	9				AP-V		SP-209 D				AP-C ⁷	SA-205 ⁷					
Glass (mineral)	10								SA-100 SA-100 ⁵	SP-206 GP		SA-100 SCP			SA-100 SA-205		
Ceramic screen print	10								SA-100	SP-206 GP		SA-100			SA-100 SA-205		
Teak	11			SP-290 DC SMM			SP-290 DC SMM									SP-290 DC SMM	
Wood and wood derivatives	11			SP-290 DC SMM			SP-290 DC SMM			SP-290 DC SMM			SP-290 DC SMM			SP-290 DC SMM	
Phenolic Plywood	12	GR-V ⁵	SP-290 DC GR-V ⁵	SMM				GR-V ⁵	SP-290 DC GR-V ⁵	SMM	GR-V ⁵	SP-290 DC GR-V ⁵	SMM		GR-V ⁵	SP-290 DC SMM	

Substrate	EN*	Sikaflex®-290 DC PRO		
		Mechanical	Adhesion Promoter	Primer
Aluminum (AlMg3, AlMgSi1)	1			
Steel (hot dipped, galvanized)	4			
Metal with shop primer	6			
Teak	12			SP-290 DC SMM
Wood and wood derivatives	12			SP-290 DC SMM

Abbreviation	Product/Explanation
AP-C	Abrasive Pad very fine (e.g. from Sia or 3M) followed by cleaning step, dry wipe or SCP
AP-V	Abrasive Pad very fine and vacuum cleaning
GR-V	Grinding (60 – 80 grit) and vacuum cleaning
SCP	Sika® Cleaner P
SA-100	Sika® Aktivator-100
SA-205	Sika® Aktivator-205
SMM	Sika® MultiPrimer Marine
SP-206 GP	Sika® Primer-206 G+P
SP-209 D	Sika® Primer-209 D
SP-290 DC	SikaPrimer-290 DC

* EN = Explanatory notes see last page.

 Recommended process
 Alternative process

PRODUCT DATA AND ABBREVIATIONS

The following product information is an abbreviated version of the current Product Data Sheets.

Sika® Aktivator	-100	-205
Color of container cap	orange	yellow
Color of product	colorless to slight yellow	colorless, clear
Type of product	Adhesion promoter	
Application temperature	The general range is 10 – 35 °C. For specific values always refer to the most recent Product Data Sheet.	
Application	Wipe with a clean and lint-free paper towel (Sika Aktivator®-100 wipe on / wipe off application is required)	
Consumption	Approximately 20 ml/m ² (depending on application method).	
Flash-off time (23 °C / 50 % r.h.)	The minimal range of the flash-off time varies from 10 to 30 minutes depending on product, substrate and climatic conditions. For specific values always refer to the most recent Product Data Sheet.	

Sika® Primer	-206 G+P	-209 D	-290 DC	Sika® MultiPrimer Marine
Color of container cap	black	green	blue	grey
Color of product	black	black	transparent, slightly yellow	
Type of product	Primer			
Application temperature	The general range is 10 – 35 °C. For specific values always refer to the most recent Product Data Sheet.			
Preparation for use	Shake bottle vigorously until the mixing balls rattle freely. Then continue shaking for an additional minute.			
Application	Brush / felt / foam applicator			
Consumption	Approximately 50 ml/m ² (depending on application method and substrate porosity).			
Flash-off time (23 °C / 50 % r.h.)	The minimal range of the flash-off time varies from 30 to 60 minutes depending on product, substrate and climatic conditions. For specific values always refer to the most recent Product Data Sheet.			

Notice: Sika® activators and primers are moisture reactive systems. In order to maintain product quality it is important to reseal the container immediately after use. With frequent use i.e. opening and closing several times, it is recommend disposing of the product one month after the first opening. With infrequent use, it is recommend disposing of the product 2 months after opening. When selecting a foam applicator, the solvent resistance must be considered. Suitable product is Sika® Cleaner PCA.

¹ Alternative: Grit-blasting with aluminium oxide

² Alternative: Sandblasting

³ If shop primer is deteriorated it has to be grinded instead of scuffed (AP)

⁴ Do not clean with solvents

⁵ Grind off phenolic layer to bare wood where adhesive or sealant have to be applied

⁶ When Sika® Aktivator-100 is used only combine with Sikaflex®-296 for this application. All other adhesives are not allowed (ensure proper UV protection)

⁷ Sikasil® SG-20 must not be applied here

⁸ Sikasil® WS-605S and SikaFiresil Marine N must not be applied here

⁹ Up to 14 days no sanding is necessary

Always consult additional information, such as General Guidelines "Bonding and Sealing with Sikaflex®", current Product Data Sheets, Safety Data Sheets, additional Product and Technical Information, etc. prior to use of the products. Project oriented solutions are documented in Technical Service reports. These solutions can vary from the table opposite and take priority over the general recommendations provided in this Pre-Treatment Chart.

LEGAL DISCLAIMER

The information contained herein and any other advice are given in good faith based on Sika's current knowledge and experience of the products when properly stored, handled and applied under normal conditions in accordance with Sika's recommendations. The information only applies to the application(s) and product(s) expressly referred to herein and is based on laboratory tests which do not replace practical tests. In case of changes in the parameters of the application, such as changes in substrates, etc., or in case of a different application, consult Sika's Technical Service prior to using Sika products. The information contained herein does not relieve the user of the products from testing them for the intended application and purpose. All orders are accepted subject to our current terms of sale and delivery. Users must always refer to the most recent issue of the local Product Data Sheet for the product concerned, copies of which can be downloaded on your local sika company website or will be supplied on request.

GLOSSARY OF TERMS

Activator

Solvent containing adhesion promoters that increase the adhesion of an adhesive on a substrate.

Adhesion

Adherence of an adhesive to a substrate.

Adhesive joint (bond-line)

Gap between two components that must be filled with adhesive.

Aging

Behaviour of the adhesive layer under the influence of time, temperature and environmental conditions.

Balanced moisture content

Moisture content of a material (specially wood) when allowed to stabilize relative to ambient levels of atmospheric temperature and air humidity.

Bonding joint

Gap between two bonding surfaces filled with adhesive.

Bondline

Contact area between adhesive and substrate.

Breaking stress

Stress required to produce failure or fracture in a material.

Clamping

Temporary securing of components in the desired position by mechanical means, with or without the application of pressure, while the adhesive is setting.

Cleaner

Chemical agent used to clean surfaces prior to bonding.

Coefficient of thermal expansion

A factor that expresses the dimensional changes in a component as a function of temperature change.

Cohesion

Inherent strength of a material.

Contact adhesive

Laminating adhesive, applied to both surfaces of the joint. Once ready, the adhesive surface is not tacky and the bonding force results only on contact of the two adhesives surfaces.

Cross-linking

Creation of a three-dimensional network through the formation of chemical bonds between molecular chains.

Curing / Setting

Setting or hardening of an adhesive due to physical or chemical reaction.

Curing conditions

Factors that influence the curing of adhesives, e.g. temperature, relative humidity.

Dew point

Temperature at which a condensation of the air humidity occurs (depending on environmental temperature and relative humidity).

Diffusion

Migration of gases or liquids through materials. The hardening process of 1-component PUR and silicones is limited by the speed of diffusion of water through the hardened skin or layer of the adhesive.

Drying time

Duration required for a primer to reach a state that will safely allow the process that follows it to be started (e.g. adhesive application).

Duromer

Crosslinked, mostly unmeltable plastics.

Elastomers

Elastomers are macromolecules with an open network structure which do not undergo plastic flow even at high temperatures approaching the point of chemical decomposition, but undergo reversible elastic deformation instead.

Elongation at break

Elongation that takes place before a material fails or fractures.

ESC

Environmental stress cracking. Cracking of thermoplastics under internal or external stress and chemicals.

Final strength

Strength of an adhesive joint when the adhesive has attained full cure.

Fillers

Additives (mostly inorganic) to improve the properties of the adhesive.

Flash-off time

Duration required for a primer, solvent, cleaner or activator to reach a state that will safely allow the process that follows it to be started (e.g. adhesive application).

FEM (Finite Element Method)

Calculation using interactive analysis methods. Calculation values are available from Technical Service Sika Industry.

Fracture energy

Energy that is required to cause a material to fail or fracture.

Galvanic corrosion

Corrosion due to the electrical contact of metals with different electrochemical potential (e.g. aluminum, steel). The use of nonconductive adhesives can stop this effect.

Handling strength

Strength level development at which the bonded assembly can be handled and passed on to the next stage of processing.

Heat resistance

The ability of a material to withstand heat without altering its state as a result of exposure to a specified temperature over a fixed period of time.

Hygric movement

Movement as a result of humidity content in the material. Particularly applies to wood but also affects other materials like PA (brand name Nylon). The values from wood depend on the type and the orientation of the grain (radial, tangential).

Joint assembly

Process of bringing the substrates together under light pressure so that the adhesive is compressed to form the adhesive bond.

Impact resistance

Resistance against abrupt forces (crash).

Modulus of elasticity

Modulus of elasticity describes the ratio of stress to strain in a rod under tension whose sides are unconstrained.

Non-sag properties

Resistance of an adhesive to collapse or slump when extruded as a bead.

1-component polyurethane adhesive

Adhesive containing isocyanate groups that cure on exposure to moisture.

Open or working time

Maximum period of time that may elapse between application of the adhesive and assembly of the joint.

Organic window

Transparent plastic such as PMMA and PC (e.g. Brand names; Plexiglas / Lexan). Thermoplastics which are prone to ESC.

Pot-life

Period of time during which multi-component adhesives can be processed after their components have been mixed. Pot-life depends on the ambient temperature and the quantity of batch mixed. It decreases with higher temperature and increased batch quantities.

Primer

A special paint coating designed to improve adhesion between adhesive and substrate. They may also have additional functions such as UV-protection of the bond line, reinforcing the substrate and some corrosion protection.

QA

Quality assurance.

Reactive adhesives

Adhesives that cure or set when exposed to heat, moisture, radiation, etc.

Resistance

Behaviour of an adhesive under changed environmental conditions.

Sag resistance (see Viscosity)

Sealant

Substance that separates a joint from any medium to which it is exposed.

Setting

Solidification of adhesive through physical and / or chemical process.

Shear modulus

Defined as the ratio of the shear stress to the shear strain in a body that undergoes simple angular deformation.

Shelf life

Period of time that can elapse between the manufacture of an adhesive and its use, subject to storage of the product under controlled conditions.

Disclaimer

The information, and, in particular, the recommendations relating to the application and end-use of Sika products, are given in good faith based on Sika's current knowledge and experience of the products when properly stored, handled and applied under normal conditions. In practice, the differences in materials, substrates and actual site conditions are such that no warranty in respect of merchantability or of fitness for a particular purpose, nor any liability arising out of any legal relationship whatsoever, can be inferred either from this information, or from any written recommendations, or from any other advice offered.

The proprietary rights of third parties must be observed. All orders are accepted subject to our current terms of sale and delivery. Users should always refer to the most recent issue of the Sika Product Datasheet for the product concerned, copies of which will be supplied on request.

Solvent

Organic liquid that dissolves the base materials and other soluble adhesive constituents without changing their chemistry.

Solids content

Nonvolatile portion of components.

Spacers

Elastic parts, mostly self-adhesive, used to control the thickness of the adhesive. The shore hardness of the spacer should be equal to or lower than that of the adhesive.

Substrates

The base materials to be bonded, e.g. fabric, steel, wood, GRP.

Tack-free or skinning time

Time between the application of a one-component adhesive and the formation of a skin on its surface, after which point bonding can no longer take place.

Tensile lap-shear strength

Breaking strength of the adhesive bond joining two parallel surfaces in a single lap joint when the joint is subjected to a shearing stress by applying a tensile load centrally to the two lapped substrates.

Tensile strength

Breaking stress of a material under tension.

Thermoplastic adhesive

Plastics that soften under the application of heat (e.g. PVC, PMMA, ABS).

Thermosetting resins

Closely cross-linked macromolecules that do not undergo plastic deformation, even at high temperatures (e.g. Polyester, Epoxy).

Thick-layer elastic bonding

Elastic bonding application where the thickness of the adhesive layer exceeds 3 mm.

Tie-coating

An industry specific term used to indicate a bonding coat or layer applied to a material to facilitate ready adhesion with other media.

Transmission

Ratio of the intensity of a beam of light passing through a body, related to its original intensity. Measured in the UV (organic glazing) and visible range (mineral glazing). Sika stipulates limits for primerless glass bonding.

TV-value

Maximum workplace concentration or highest admissible concentration of evaporating solvent at a workplace. Two-part polyurethane adhesive Adhesive formed by the addition reaction of two components; main component and hardener.

UV-radiation

High energy part of sunlight, mainly responsible for surface degradation of organic materials like paint, sealants, etc.

Viscosity

Resistance to flow exhibited by fluids or paste-like substances as a result of internal friction.

White spirit

Petroleum spirit solvent, common used for thinning and cleaning.

Wetting

Ability of liquids to disperse themselves uniformly over solid materials.

Wet bonding

Method of bonding whereby the adhesive is applied by wetting.

GLOBAL, OG LOKAL SAMARBEIDSPARTNER

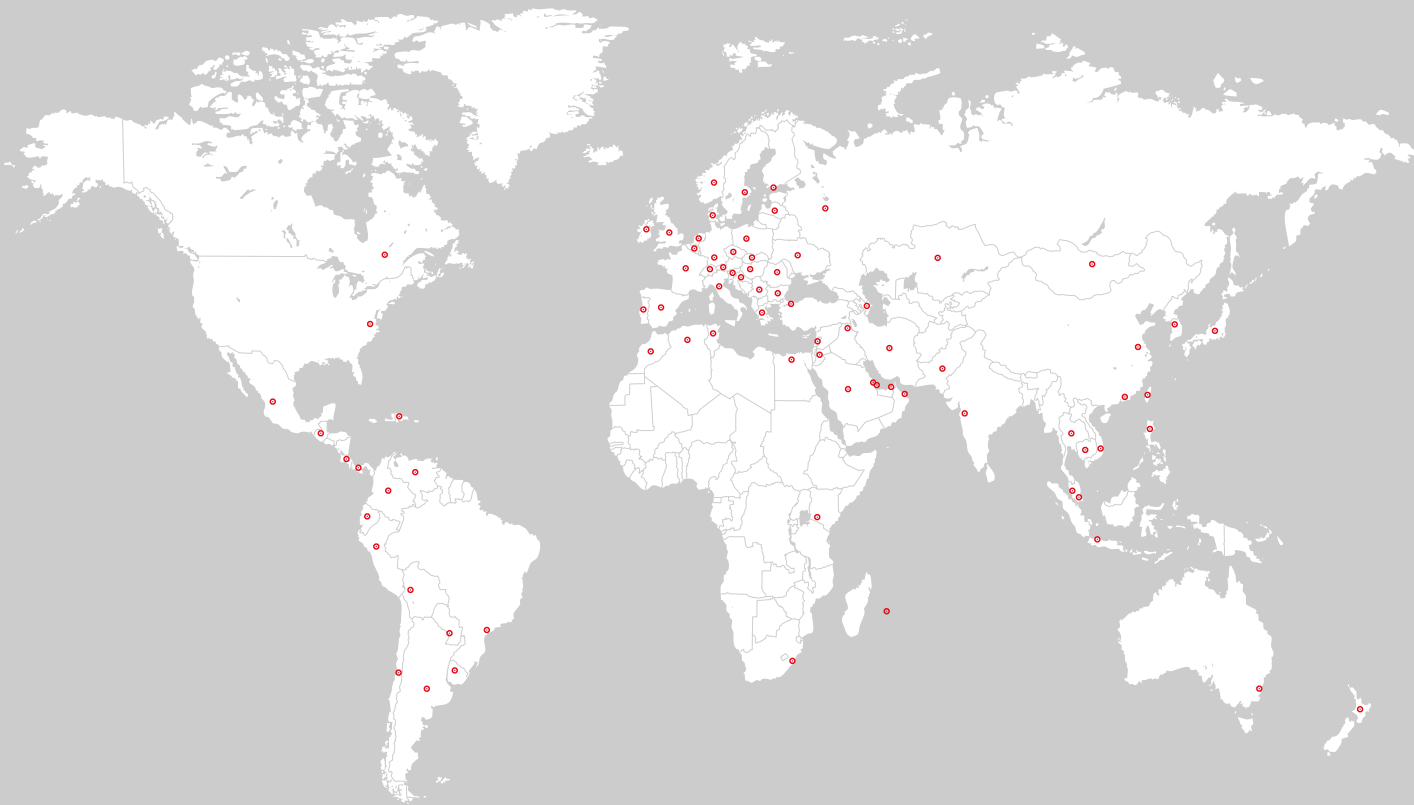

FOR MER INFORMASJON:



www.sika.no/marine

HVEM ER VI

Sika er et verdensomspennende konsern med hovedkontor i Sveits. Selskapet har en ledende posisjon innen utvikling og produksjon av kjemiske produkter til bygg, industri, marine og offshore.

Vi leverer løsninger innen fuging, tetting, tilsetning til betong, betongreparasjoner, forsterkning og beskyttelse, samt løsninger til gulv- og taksystemer.

Våre generelle salgs- og leveringsbetingelser er alltid gjeldende.
Konferer alltid med gjeldende produkt- og sikkerhetsdatablad før bruk.
Med forbehold om skrivefeil.



Sika Norge AS
Sanitetsveien 1
2013 Skjetten
Postboks 71, 2026 Skjetten

Kontakt oss
Tlf.: 67 06 79 00
industri@no.sika.com
www.sika.no

BUILDING TRUST

